

Meridian™

User Guide

Preface

Thank you for choosing Meridian™ for your business needs.

This User Guide contains all the information you need to make effective use of Meridian™.

The User Guide is in two parts: the **Meridian™ Reference Section** is designed to help you understand the information contained in the data; the **Meridian™ Format Section** is designed to help you load the data into your software.

Contact Details

Customer Services - Digital Help Desk will be pleased to deal with your enquiries.

Customer Services - Digital Help Desk

Telephone: 01703 792773

Fax: 01703 792324

E-mail: dighlpdesk@ordsvy.gov.uk

or write to:

Customer Services - Digital Help Desk

Ordnance Survey

Romsey Road

SOUTHAMPTON

United Kingdom

SO16 4GU

Product Performance

If you have any problems or identify any errors in the data, please complete the Product Performance Report Form at Appendix E in the Reference Section.

Liability

This User Guide has been checked and validated before issue and every endeavour made to ensure that the contents are accurate. If you find any errors or omissions please write to us at the address shown above so that we can investigate them.

Ordnance Survey makes every effort to ensure that data supplied are free from errors and omissions. We will remedy, as soon as reasonably practicable, errors and omissions the Customer notifies to Ordnance Survey in writing. It is the Customer's responsibility to ensure that data ordered are suitable for the intended purpose. Ordnance Survey will not be liable to the Customer or any other party for any loss, damage, inconvenience or expense resulting from the use of, or reliance upon, the data.

Trade Marks

Ordnance Survey and Land-Line are registered trade marks and the OS symbol and Meridian are trade marks of Ordnance Survey, the National Mapping Agency of Great Britain.

MS-DOS is a registered trade mark of Microsoft Corporation in the United States and other countries. UNIX is a registered trade mark of UNIX Systems Laboratories. AutoCAD is a registered trade mark and DXF is a trade mark of Autodesk Inc.

Reference Section Contents

| | | |
|-----------|------------------------------------|------|
| | Preface | |
| Chapter 1 | Introduction | 1.1 |
| | Meridian Features | 1.2 |
| | Applications of Meridian | 1.3 |
| | What You Need to Use Meridian | 1.4 |
| | Computer Hardware | 1.4 |
| | Computer Software | 1.4 |
| | Output of Meridian Information | 1.5 |
| | Supply | 1.6 |
| | Meridian Supply Options | 1.6 |
| | Meridian Supply Formats | 1.6 |
| | Meridian Supply Media | 1.6 |
| Chapter 2 | Overview of Meridian | 2.1 |
| | Data Overview | 2.1 |
| | Basic Principles | 2.1 |
| | Meridian Vector Data Structure | 2.2 |
| Chapter 3 | Meridian Explained | 3.1 |
| | Features | 3.1 |
| | Points and Lines | 3.2 |
| | Feature Position | 3.5 |
| | Feature Attribute Data | 3.6 |
| | Feature Codes | 3.6 |
| | Names as Attributes | 3.8 |
| | Road Number | 3.8 |
| | Trunk Road | 3.8 |
| | Junction Name | 3.9 |
| | Unique Identifiers | 3.10 |
| | Link Level at Node | 3.11 |
| | Feature Layer Descriptions | 3.12 |
| | Roads | 3.12 |
| | Railways | 3.12 |
| | Administrative Areas and Coastline | 3.13 |

| | | |
|------------|---------------------------------|------|
| | Developed Land Use Areas | 3.14 |
| | Cartographic Names | 3.15 |
| Appendix A | Quality Statement | A.1 |
| | Source of Meridian | A.1 |
| | Currency | A.2 |
| | Accuracy and Resolution | A.2 |
| | Completeness | A.2 |
| Appendix B | The National Grid | B.1 |
| Appendix C | Glossary | C.1 |
| Appendix D | Terms and Conditions | D.1 |
| | Use of Meridian | D.1 |
| | Delivery of Meridian | D.1 |
| | Invoice | D.1 |
| | Copyright | D.2 |
| Appendix E | Product Performance Report Form | E.1 |

Format Section Contents

| | | |
|------------|---|------|
| Chapter 1 | Introduction | 1.1 |
| | Meridian General Specifications | 1.2 |
| Chapter 2 | Introduction to Data Formats | 2.1 |
| | NTF | 2.1 |
| | Drawing Interchange File (DXF) | 2.4 |
| Chapter 3 | NTF Explained | 3.1 |
| Chapter 4 | DXF Explained | 4.1 |
| | Introduction | 4.1 |
| | Overview | 4.1 |
| | Structure of Meridian | 4.1 |
| | Drawing Content and Format | 4.3 |
| | Coordinate System | 4.3 |
| | Height | 4.3 |
| | Layer Names | 4.3 |
| | Neatline | 4.3 |
| | Grid | 4.4 |
| | Grid Values | 4.4 |
| | DXF Layers | 4.5 |
| Appendix A | NTF File Structure for Meridian | A.1 |
| | An Overview of the Data in NTF | A.1 |
| | Outline Description of the Data Structure | A.2 |
| | Supply of Data on Unformatted Media | A.3 |
| | Supply of Data on Formatted Media | A.4 |
| | Version Management | A.7 |
| | General | A.7 |
| | Section Body | A.8 |
| | Point and Line Features | A.8 |
| | Name Detail | A.9 |
| | Node Detail | A.10 |
| | Feature Information Relevant to NTF | A.11 |

| | | |
|------------|--|------|
| | Point Features | A.11 |
| | Line Features | A.11 |
| | Coordinates | A.12 |
| | Bearings | A.12 |
| | Attribute Codes | A.13 |
| | Unique Identifiers | A.14 |
| | Record IDs | A.14 |
| | Feature Layers | A.16 |
| | Record Breakdown | A.18 |
| | NTF Record List | A.18 |
| | Volume Header Record [VOLHDREC] 01 | A.19 |
| | Database Header Record [DBHREC] 02 | A.20 |
| | Feature Classification Record [FEATCLASS] 05 | A.21 |
| | Section Header Record [SECHREC] 07 | A.22 |
| | Attribute Record [ATTREC] 14 | A.24 |
| | Point Feature Record [POINTREC] 15 | A.33 |
| | Node Record [NODEREC] 16 | A.34 |
| | Two-Dimensional Geometry Record [GEOMETRY1] 21 | A.35 |
| | Line Feature Record [LINEREC] 23 | A.37 |
| | Attribute Description Record [ATTDESC] 40 | A.38 |
| | Text Record [TEXTREC] 43 | A.40 |
| | Text Position Record [TEXTPOS] 44 | A.41 |
| | Text Representation Record [TEXTREP] 45 | A.42 |
| | Volume Terminator Record [VOLTERM] 99 | A.43 |
| Appendix B | DXF File Structure for Meridian | B.1 |
| | General | B.1 |
| | Data Structure | B.2 |
| | Header | B.3 |
| | Tables | B.6 |
| | Blocks | B.12 |
| | Entities Section | B.13 |
| | End of File Group | B.17 |

Chapter 1 Introduction

This **Reference Section** is designed to enable users to make effective use of Meridian, and contains all the information you will need.

This Chapter and Chapter 2 provide an introduction to Meridian and illustrate potential applications. Chapter 3 contains details of the components of the data. Please refer to the Glossary if you are unfamiliar with the terms used.

All aspects of Meridian discussed in this User Guide relate to Meridian in both BS 7567 (NTF v2.0) and DXF (AutoCAD Release 12) formats. If the two format versions differ in their treatment of a particular aspect, the specific differences will be stated. Icons, as shown below, will be used to denote these differences.



For convenience BS 7567 (NTF v2.0 level 2) is referred to as NTF in this Section.



Drawing Interchange File (DXF) is referred to as DXF in this Section.

For information on the Meridian data format, please refer to Part 2 of the User Guide.

Ordnance Survey's Meridian provides a comprehensive national database of geographic (spatial) information designed to support a wide range of applications including initial planning and project work at a regional level. Concepts of Meridian are explained fully in Chapter 2.

Appropriate software is required to facilitate the customer's intended application.

The database has been derived from Ordnance Survey's existing large and small scales digital databases. Railways have been digitised from Ordnance Survey's *1:50 000 Scale Colour Raster* data.

Meridian Features

- Meridian has feature codes which allow everything in the database to be allocated to a specific category; users can group like-features for search, display and output routines.
- Meridian is defined as a limited 'link and node' structure within each layer. It contains points, lines and nodes. Nodes have pointers to lines that join at the node and similarly, there are lines that enclose an area containing a point. Some points are not contained within areas enclosed by lines.
- Department of transport road classification numbers are stored in attribute records and are applied to features such as roads. Names applying to administrative areas and developed land use areas are also included in the attribute record of the appropriate point feature
- Annual updating of source databases ensures that high standards of currency and integrity are maintained.
- Enhancement of Meridian incorporating selected additional features is proposed from October 1997.

Applications of Meridian

There are many potential applications for Meridian. These include:

- Environmental analysis
- Land management
- Commercial/business site development
- Routing Analysis
- Retail/Wholesale Trades
 - Distribution networks
 - Store/warehouse locations
 - Strategic business expansion/development
- Marketing and Media Planning
 - Sales force locations/territories
 - Sales prospecting
 - Market analysis of customers, competitors or outlet densities
 - Market analysis of direct mail responses
 - Poster distribution
 - TV/Radio advertising Regions
 - Product/Brand promotion campaigns
- Financial/Insurance
 - Customer bases
 - High/Low risk areas
- Health
 - Community health
 - Health black-spots
- Leisure Activities
 - Large site planning, e.g. golf courses
 - Tourism
 - Theme Park locations.

What You Need to Use Meridian

Computer Hardware

Providing that sufficient memory and storage facilities are available there are no constraints on hardware platforms which can be used. The range of hardware which can typically be used varies from higher specification personal computers (PCs) to mainframe computers.

Computer Software

Meridian is inert data and does not include software for data manipulation. To exploit fully the potential of Meridian it is necessary to use appropriate application software. There are many proprietary systems available and Ordnance Survey publishes a list of Geographical Information Systems (GIS), CAD and Digital Mapping System Suppliers who have confirmed their software can import NTF format. Contact Customer Services - Digital Help Desk for a current list of these details, see Contact Details at the beginning of this User Guide.

Output of Meridian Information

Meridian is inert data. It requires software (not provided by Ordnance Survey) to display it on a screen or to plot it out as hard copy.



The parameters defining colours, line styles, text styles, symbols, etc. should be built into user software. Symbol definitions used by Ordnance Survey are given in the Meridian Format Section.



The parameters defining colours, line styles, text styles, symbols, etc. are embedded within the DXF file, as is customary with this CAD format.

Meridian may be customised by viewing or plotting features in different colours, line styles and scales to suit different applications. Certain classes of features may be omitted from customised plans on the basis of selection by feature code.

Supply

Meridian Supply Options

The options for data supply are as follows:

- Complete national cover of Great Britain (805 tiles)
- Regional Area data are supplied along tile lines containing whole counties.
 - Northern Scotland (205 tiles)
 - Southern Scotland (151 tiles)
 - Northern England (134 tiles)
 - West and East Midlands (101 tiles)
 - South East England (134 tiles)
 - South West England (98 tiles)
 - Wales (84 tiles)(these areas correspond with Nomenclature des Unites Territoriales Statistique (NUTS) Level 1 Areas)
- 20 km by 20 km tiles

Meridian Supply Formats

Meridian is available in:

BS 7567 (NTF v2.0 Level 3)

DXF (conforming to AutoCAD release 12 with Extended Entity Data).

Meridian Supply Media

NTF is supplied on the standard Ordnance Survey media options.

DXF is supplied on CD-ROM only.

Chapter 2 Overview of Meridian

Data Overview

Basic Principles

Links represent roads, railways, administrative areas, coastline and developed land use area lines.

Nodes represent all intersections of links within each layer, changes in attributes in links and link ends.

Each feature has associated geometry; this may be a single coordinate pair for a single point feature for a railway station or two or more coordinate pairs for a linear feature.

Each feature is classified by means of a feature code.

Roads, railways, railway stations, administrative area seed points and developed land use area seed points have unique identifiers.

Meridian Vector Data Structure

Meridian data within each layer are supplied as vector data, in a link and node structure. Geographical features are represented as data entities either as points or lines. Points are fixed positionally by one coordinate pair, e.g. a railway station. Lines are fixed positionally by a series of connected coordinate points to represent linear map features such as roads, railways, etc. Points and lines within the data model determine the **geometric** (positional) characteristics of the data.

Points and lines within the data model also have associated attributes. These give the point and line entities meaning, i.e. they represent the descriptive characteristic of an entity such as a feature code, a name or numerical value. Lines are also added as closing links (neat lines) along tile edges; these are required to complete the enclosure of an area. The closing link has a different feature code to the other links enclosing the area.

Throughout the Meridian product no line feature crosses from one tile to the next, but a point feature created at the tile edge has the same coordinate value as its partner on the adjacent tile.



All features having the same Feature Code are recorded on the same layer. DXF has a limited 'link and node' structure; within this structure, a feature may be a name, point or line. Each feature is free-standing, i.e. its topological relationship to any other feature is not expressed in the data.

Other important data structure concepts include **networks** and **polygons**.

Networks are interconnecting features structurally related by means of an explicit point described as a **node**. Between the nodes are series of non-intersecting line segments described as **links**; hence link and node - see figure 2.1. This is of special interest in GIS where there may be a need to analyse the network in order to follow routes or to close polygons.

Proprietary GIS software can be used to build and maintain networks for linear features such as roads, railways, etc, and provides the functionality to store, manage and manipulate these data.

The properties of Meridian make it suitable as the basis for users wishing to develop applications using Meridian together with their own data. As Meridian is based on the National Grid there is a simple way of overlaying users' own data provided the position is given within the National Grid.

The National Grid as it applies to Meridian is explained at Appendix B.

Figure 2.1: Link and Node

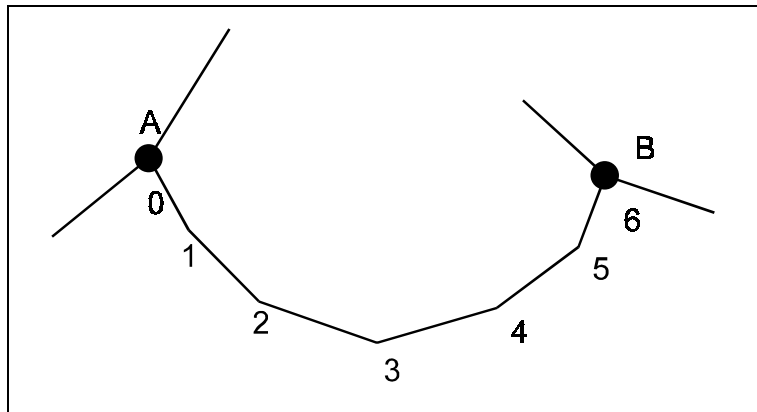

Points A and B are nodes, as they intersect with other features. The line A-B is the link, and, in this example, is made up of 6 individual line segments.

Polygons are continuous areas defined by sets of bounding closed lines. These are implicit within the data, but can be explicitly created with appropriate software. Stored within recognisable polygons are **seed points**, which hold information about that polygon, e.g. a county name.

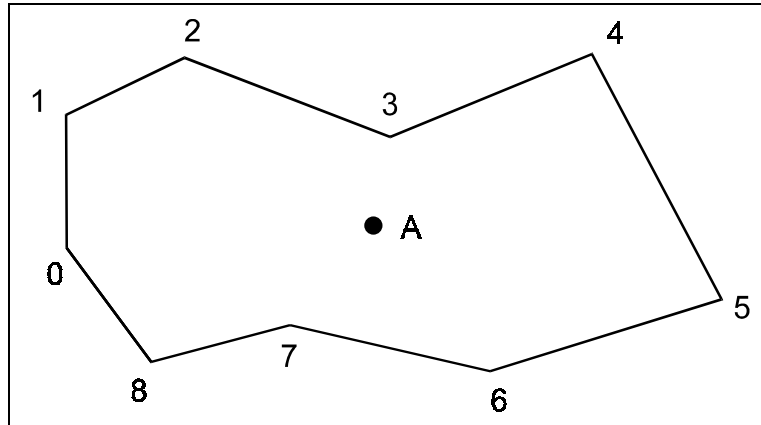
Figure 2.2: Polygon

Point A is the polygon seed point for the area: attached to this point are attributes such as the feature code which defines the polygon and its definitive name. These attributes may be transferred to the polygon itself. The polygon, in this example comprises 9 individual line segments.

There are also free-standing points which are not associated with a defining polygon, e.g. New Street Station.

Chapter 3 Meridian Explained

Features

Meridian has two feature classes:

- Point features
- Line features.

Point features such as administrative area seed points and line features such as roads, railways and developed land use areas are arranged into recognisable categories. A full listing of individual features is given in Appendix A of the Format Section.

Each feature has two components:

- Feature position
- Feature attribute data.

Also covered in this Chapter:

- Feature layer descriptions.



Each feature recorded in Meridian should be considered as a DXF Entity. Line features are recorded as DXF Line(s) or Polyline(s).



Point features will be recorded in the data as INSERT BLOCKS. Certain standard symbols are defined in the BLOCKS section of the data file. A list of these standard symbols is shown in the Format Section. Attributes are stored as Extended Entity Data.

Points and Lines

Real world geographic features are represented in the digital map data as structures of lines and points. Each point or line has a geometric and attribute component.

The geometric component defines the positional characteristic of the feature, and implicit relationships exist between points and lines based on relative position. The attribute component defines the descriptive characteristics of the feature.

Points may exist independently of lines.

A diagrammatic example of a geometric structure is shown in figure 3.1a.

Figure 3.1a: A geometric structure of points and lines.

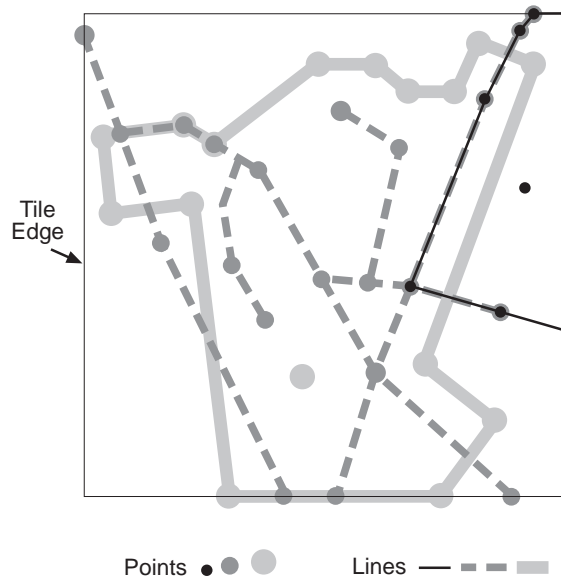

Solid black, grey and broken grey lines and associated points are on different layers.

Points and Lines from the geometric structure become features when an attribute, the feature code, has been added, e.g. developed land use area seed points are created from points, or developed land use area boundaries from lines.

Figure 3.1b: The same geometric structure as features

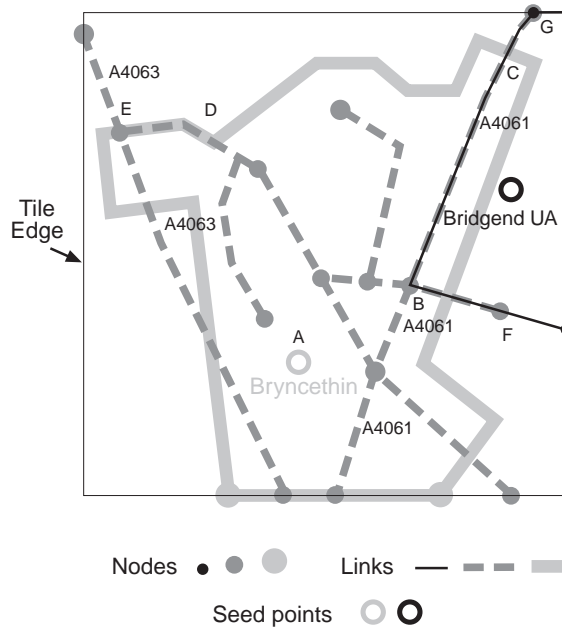

Solid black, grey and broken grey are on different layers.

In Figure 3.1b:

Point A is a seed point with a feature code that identifies it as a developed land use area, the seed point also carries its name attribute - Bryncethin.

Point B is a coordinate junction between intersecting features - in this case, where a minor road intersects with the A4061. This is an example of a node.

Point C is a position where the A4061 in one layer crosses the developed land use area boundary in another layer. There is no node at this point.

Some points and lines are common to more than one feature, as in figure 3.1b. Features between D-E and G-B-F are overlapping features and are stored separately within each layer of data.

Separate storage of overlapping features

Figure 3.1c: Roads

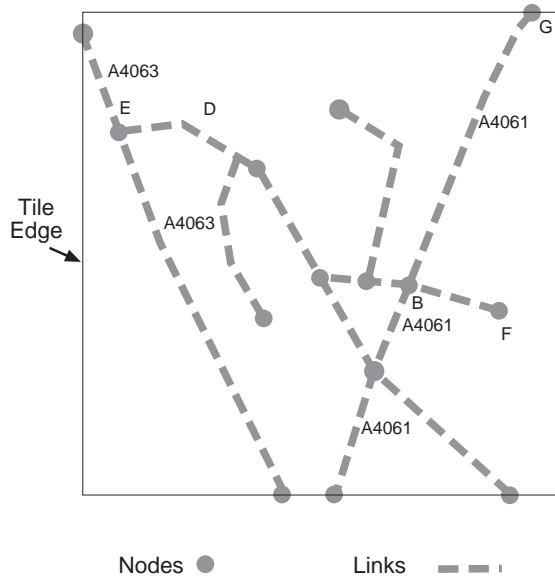
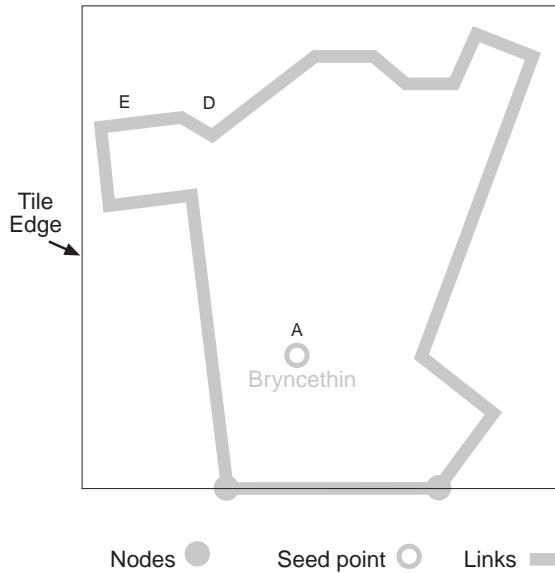
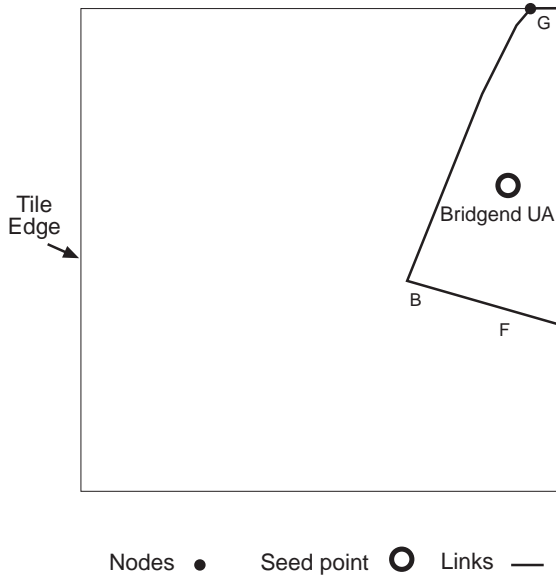

Figure 3.1d: Developed Land Use Area



In figures 3.1c and 3.1d line D-E is common to the minor road and the developed land use area boundary and the geometry of each feature is stored separately.

Figure 3.1e: Administrative Areas and Coastline

In figures 3.1c and 3.1e line G-B-F is common to the A4061, the minor road and administrative area boundary and the geometry of each feature is stored separately.

Feature Position

The geometry of map features is defined in terms of coordinates. All coordinates used in Meridian are based on the National Grid (NG) coordinate referencing system, and are quoted to a 1 metre resolution.

The National grid, as it applies to Meridian, is explained more fully in Appendix B.

Feature Attribute Data

An attribute is the descriptive characteristic of a feature, i.e. a non-spatial element.

The geometry of the points and lines within the data would be meaningless to the user unless they are assigned some distinguishing property. In Ordnance Survey map data terms, an attribute can be a feature code (in NTF these are numeric codes), e.g. 6001, or a distinctive name or number, e.g. 'Birmingham' or 'M40'.

Attribute codes relevant to NTF are listed and described within the **Format Section** but an overview is given below.

Feature Codes

Each feature is classified by means of a feature code (FC). A feature code is allocated when each feature is initially interpreted and captured from the map base. In this way, an A road is distinguished, by the feature code allocated to it, from a B road and other kinds of line feature.



Each feature is classified as belonging to a specific feature layer. These layers range in value from G8050570 to G8056801, using the BS 1192 Part 5 Guide for structuring of computer information. These feature layers are listed in Chapter 2 of the Format Section. Attributes are stored as Extended Entity Data .

A further four text feature codes for Layout of Footnotes are included. These feature codes are listed in the Format Section.

In order to display the attributes stored as extended entity data, the following two scripts are required. These two files, 'Showeed.lsp' and ' Showeed.dcl', are contained in the 'EXE' directory on the Ordnance Survey-supplied CD-ROM and should be placed in a directory in the AutoCAD preferences search string. This should include the directory containing the map data files in DXF.

To utilise the scripts, type the following at the AutoCAD command line prompt within a drawing session:

```
AutoCAD:      (load "showeed")
AutoCAD:      eedd
```

Selecting a map feature will now display the allied attributes of that feature in a dialogue box. To interrogate other features, the 'Re-Select' option on the user dialogue box should be chosen. The 'Cancel' option will return the user to a normal AutoCAD session.

If the 'eedd' command is repeated at the command prompt, the facility will again be available to the user.

The visibility of extended entity data to software other than AutoCAD Release 12 will be constrained by the functionality of those individual software applications.



Each feature is classified as belonging to a specific feature code. These feature codes are listed in Chapter 2 of the Format Section.

These differences in the data are inferred during translation from Ordnance Survey's internal data format to the required customer transfer format.

Names as Attributes

The criteria for names attribute attachment are as follows:

- **Admin Name (NM)** is an attribute of a seed point in its administrative area, e.g. Hampshire County
- **Proper Name (PN)** is an attribute of a seed point in a developed land use area, e.g. Bexhill, or a node point for a railway station, e.g. Great Ayton Station
- **Text (TX)** is a text string transferred in an attribute record to be displayed as 'standalone' cartographic text, e.g. Sidley, a place name.

Road Number

The Road Number (RN) attribute defines the Department of Transport (DoT) road classification number e.g. M40 which relates to a **link**. If a road is not classified then this attribute will not be present.

Trunk Road

The Trunk Road (TR) attribute defines whether the **link** forms part of a trunk road. If it is then the link will have a trunk road attribute with a value of 'Y' and if it is not a trunk road then there will be no value in this field.

Junction Name

The Junction Name (JN) attribute indicates the junction number of motorway junctions, and the other classified roads at that junction. The junction name is variable length text, and is in the format 'M6J10A', where 'M6' is the DoT road number, and 'J10A' indicates that this is the junction numbered 10A of the M6. If the junction has no junction number, then that part of the junction name is not supplied.

There could be any number of roads at a junction, therefore each classified road at that junction may be repeated in the junction name attribute. Each road number and junction is separated by a forward slash character (/). The following is an example of a junction name attribute:

M40J1/A40/A413/A4020

This attribute only applies to **nodes**. If the node does not have a junction name, then this attribute is not present.

Unique Identifiers

Unique Identifiers are used to uniquely identify some features within Meridian. These are:

- **Ordnance Survey Meridian Database Reference (OSMDR).** This uniquely identifies any road link or road node within the national Meridian database and is compatible with the OSCAR family of products. Interchange of data between Meridian and OSCAR is possible with software modification.
- **Railway and Railway Station Identifiers.** These uniquely identify any railway link or railway station within the national Meridian database.
- **Developed Land Use Area Identifier.** This uniquely identifies any developed land use area seed point within the national Meridian database.
- **Global Identifier.** This uniquely identifies any Administrative Area seed point within the 20 km by 20 km tile.

The Unique Identifiers are unique references and will be maintained, except where there has been significant change to a feature.

The Unique Identifier may refer to several links representing a linear object across tiles, e.g. a road or a railway, which may be chained together across tile edges. Thus, on adjoining tiles, there may be two or more links with the same unique identifier.

Unique identifiers have been assigned to all existing roads (links and nodes), railway links and railway stations and to seed points for administrative areas and developed land use areas. Any of these features which are new to Meridian after the initial allocation will be assigned an appropriate unique identifier when the database is refreshed.

The Unique Identifier for a feature will never be modified - only created and deleted. If a feature is deleted from the Meridian database, then the Unique Identifier allocated to that feature will cease to exist.

OSMDR There may be many changes to a feature with a specific OSMDR during the lifetime of that OSMDR allocation. There are two reasons for these changes:

1. The coordinates of the feature may move within a specified tolerance - currently 3 metres. Any changes to the feature within this tolerance will mean that the OSMDR will be retained for the feature.
2. The attributes associated with a feature may change. Any changes to these attributes will not affect the OSMDR allocated to that feature. The following attributes may change for link features:
 - Feature Code
 - Trunk Road indicator
 - Road Number

The following attributes may change for node or point features:

- Direction of Links at Node
- Feature Code
- Junction Name
- Number of Links at Node
- Level of Link at Node
- Name

If a feature moves by more than the specified tolerance, currently 3 metres, then the OSMDR for the feature will be deleted and a new OSMDR allocated to that feature.

Link Level at Node

In Chapter 2 of the **Format Section**, the level field in Node Record 16 indicates - for roads - the relative height relationship between intersecting links at a node. It does not relate to ground surface level. If a road over a bridge can be accessed then a level value of 0 is used; a value of 1 used when there is no access from one road to the other at an intersection.

Feature Layer Descriptions

The feature codes which appear in Meridian within each layer are detailed in Chapter 2 of the **Format Section**. The individual layers, are described in the following sub-sections:

Note: Names or numbers appear in all layers as attributes.

Roads

Motorways, major and minor roads are represented in the data. Complex junctions are collapsed to single nodes and multi-carriageways to single links. To avoid congestion some minor roads and cul-de-sacs are not represented in the minor road feature description of the data. Private roads and tracks are not included.

Railways

All railway stations open to passengers and multiple and single track passenger lines are represented.

A railway intersection consists of links and a node, but where railways cross at different levels, links are not broken. Links and nodes carry a feature code. Points carry a railway station name if it differs from the built up area name on Ordnance Survey's 1:50 000 scale colour raster data, e.g. New Street Station in Birmingham, or if the railway station name is not associated to any built up area name, e.g. Great Ayton Station. These node attributes are also shown as cartographic station names.

To maintain positional relationship, features in this layer may be adjusted and fitted to the roads.

Administrative Areas and Coastline

Administrative areas includes information for new Unitary Authority Areas for Scotland and Wales and County, District and London Borough boundaries for England.

Figure 3.2: Hierarchical relationship of boundaries for England

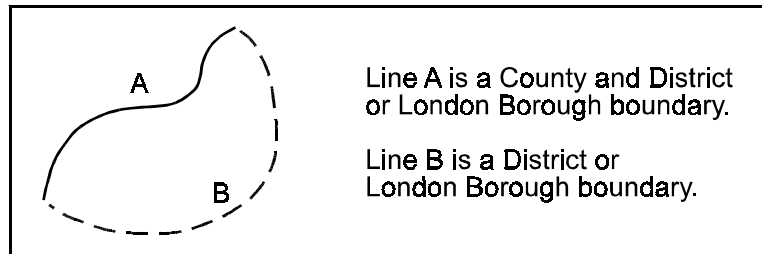

Each link for an administrative area carries a feature code and the administrative level associated with the left and right sides of that link. This also applies to coastline, but only to the land side of the coastline, i.e. no administrative area information is added to the seaward side.

Each administrative area contains a seed point that identifies the enclosed area and carries a feature code and the associated administrative area name. Separate areas of the same administrative unit carry seed point with different identifiers.

Offshore islands carry a County and District or Unitary Authority seed point. There is no logical connection in the data between them and administrative units, other than the same name attribute.

There is no explicit information to identify which links form the bounds of a particular area. The left and right County and District pointers on links do not contain the name of the administrative area, but refer to the seed point that has the administrative area name as its attribute.

The coastline follows the Mean High Water (MHW) up all estuaries to the normal tidal limit (NTL). Administrative areas are only shown down to MHW.

The administrative areas are adjusted to the coastline.

To maintain positional relationship, features in this layer may be adjusted and fitted to roads and railways.

The Local Authorities of Wales and Scotland have been changed to create a single tier of administration at the local level, operative from 1 April 1996. These boundaries have been included in the Meridian database.

Local Government in England is still under review although some counties have been concluded. The operative dates for the new authorities extend from 1 April 1995 through to 1 April 1998. In view of this gradual change-over from two-tier Local Government to a mixture of single- or two-tier authorities, the Authorities in place at 1 April 1994, and currently still in operation, have been used on this occasion. An exception to this is the Isle of Wight which is already a single-tier Authority.

Developed Land Use Areas

Developed land use area features include cities, towns, villages and industrial, commercial and business parks.

Developed land use area features are enclosed by link features. Such areas contain a seed point that identifies the enclosed area and carry a feature code and the associated developed land use area name. There is no explicit information to identify which link forms the bounds of a particular area.

The whole developed land use area has been positioned to the road pattern by 'best fit' practice.

Cartographic Names

Place names from the Small Scales database and railway station attribute names are also shown as independent text features and located near the feature that they describe.

Place names are collapsed from double-banked, treble-banked or composite text to a single text feature with all the text as one string.



The text font 'STANDARD' and text height in metres have been used for these cartographic names and are as layers separate from the feature with which they are associated.



The text font identifier of 0004 (Univers Medium Roman Condensed) and text height in millimetres has been used for these cartographic names and is transferred with the text feature.

The Ordnance Survey convention for the digitising of names is as follows: all names are digitised as point features, given as X and Y National Grid coordinates. The point has been digitised relative to the map feature it describes, and the actual point represents one of the standard positions as illustrated below:

Figure 3.3: Standard Ordnance Survey text positions

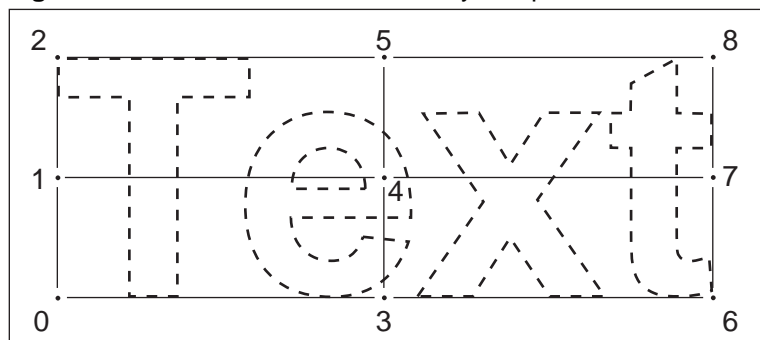

Names are normally placed on the printed map parallel to the horizontal grid.



Position 0 is supplied.



The text string may start, end or be centred on this coordinate pair; the relationship of the text to its coordinate pair is expressed as an 'original digitised position'. Where the position of text features are recorded, one of these positions is digitised.

Appendix A Quality Statement

Source of Meridian

Meridian data are derived from Large and Small Scales digital databases. The data capture source and scales are:

| Feature | Data Source | Source Scale |
|--|----------------------------|-----------------------------|
| Road network | Road centre-lines database | 1:1250, 1:2500 and 1:10 000 |
| County, District and London Borough boundaries for England | Boundaries database | 1:10 000 |
| Unitary Authority Areas for Wales | Boundaries database | 1:10 000 |
| Unitary Authority Areas for Scotland | Large Scales database | 1:1250, 1:2500 and 1:10 000 |
| Coastline | Small Scales database | 1:50 000 |
| Developed Land Use Area and place names | Small Scales database | 1:250 000 |

Main railways, railway stations and station names have been digitised from Ordnance Survey's 1:50 000 Scale Colour Raster data for Meridian.

Currency

Meridian data are derived from the latest available versions of Ordnance Survey's databases. The Meridian database will be refreshed annually commencing October 1997.

The Large and Small Scales databases are controlled by the revision criteria for topography that are defined by Ordnance Survey for the various geographical areas.

Accuracy and Resolution

The resolution of the data supplied is 1 metre. Meridian data retains the same accuracy as the source data during its capture. However, it is not possible to calculate meaningful accuracy criteria for these data due to different source databases.

Administrative areas and roads data have a 20 metre lateral filter applied to the boundary and centre-lines. The 20 metre filter does not affect the positional accuracy of node points.

Features derived from the Small Scales databases have been subjected to generalisation where accurate positional representation would have caused confusing clutter. To maintain positional relationships such data have been further adjusted to roads and railways where necessary.

Completeness

During production many checks are undertaken to ensure that data supplied to customers are both accurate and complete.

These quality control checks take the form of:

- visual checks by operators
- independent quality assurance checks
- computer validation within the flowline.

Appendix B The National Grid

Meridian tiles are identified by quoting the National Grid reference of the south-west corner of the area they cover. The Ordnance Survey National Grid divides Great Britain into squares 100 km by 100 km. Each of these squares has a unique two-letter reference, e.g. TQ in the diagram below.

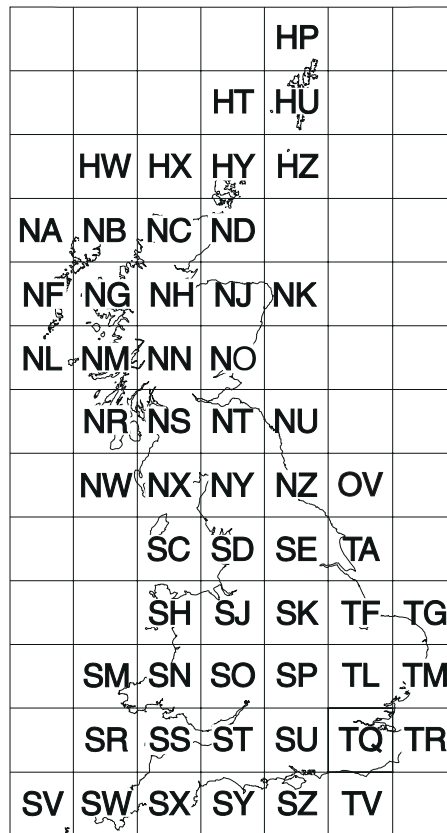

Each Meridian 20 km by 20 km tile is described by adding a two-digit reference to the 100 km by 100 km square reference, with the Easting first followed by the Northing, e.g. TQ26.

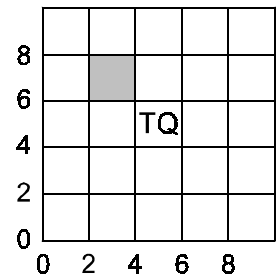

© Crown copyright

Appendix C Glossary

Accuracy

The closeness of the results of observations, computations or estimates to the true values or the values accepted as being true. Accuracy relates to the exactness of the result, and is the exactness of the operation by which the result is obtained.

Administrative Area

A blanket term used by Ordnance Survey to refer to all public administrative areas, specifically Local Government management and electoral areas.

American Standard Code for Information Interchange (ASCII)

A 7-bit code for encoding a standard character set.

Area

A spatial extent defined by circumscribing lines that form a closed perimeter that does not intersect itself.

Area Seed

A point within an area that can be used to carry the attributes of the whole area, e.g. ownership, address and use type.

Asset Management/Facilities Management (AM/FM)

An American term for computerised information systems involving digital mapping used by utilities, for example, to manage their plant.

Attribute

An attribute is a property of an entity, usually used to refer to a non-spatial qualification of a spatially referenced entity. For example, a descriptive code indicating what an entity represents, or how it should be portrayed.

Attribute Class

A specific group of attributes, e.g. those describing measure, serviceability, structure, or composition.

Attribute Code

An alphanumeric identifier for an attribute type.

Attribute Value

A specific quality or quantity assigned to an attribute.

Basic Scale

The scale at which the survey is maintained. For Ordnance Survey mapping, three scales (1:1250, 1:2500, 1:10 000) are used. Any area is only maintained at one basic scale.

Bearing

Bearings are angles measured against National Grid bearings in degrees. They are measured clockwise from Grid North.

Block

Data on magnetic media may be recorded in blocks of characters for more efficient movement within or between computer systems. The length of the block will vary according to the medium and the data transfer format used.

Boundary

A boundary is the limit of a predefined and established area whose limit is determined by one or more **Lines**, e.g. County area boundary and developed land use area boundary.

Byte

A unit of computer storage of binary data usually comprising 8 bits, equivalent to a character. Hence **Megabyte** (Mb) and **Gigabyte** (Gb).

CAD

Computer Aided Design

Cartography

The organisation and communication of geographically related information in either graphic or digital form. It can include all stages from data acquisition to presentation and use.

Character

A distinctive mark; an inscribed letter; one of a set of writing-symbols.

Character String

A one-dimensional array of characters held either in memory or in another storage medium.

Coding

Allocation of a feature code to a feature being created from constituent construction data - points and/or segments; with optional linking to an existing feature of the same feature code.

Compact Disc - Read Only Memory (CD-ROM)

A data storage medium. A 12 cm disc similar to an audio CD. Ordnance Survey uses the Writable CD, a WORM (write once read many) device. The digital 'bits' are encoded into a vegetable dye and, once written, cannot be erased by overwriting with subsequent data. The disc is read by laser.

Continuation Mark

A logical record may contain more data than can be held in a single physical record. The physical record contains a continuation mark - the penultimate character of the record in NTF - to indicate whether more data is to be found in a continuation record.

Continuation Record

A specific NTF term. A continuation record is used where space does not allow one logical record to be contained wholly within one physical record.

Coordinate pair

A coordinate pair is an Easting and a Northing.

Coordinates

Pairs of numbers expressing horizontal distances along original axis. Alternatively triplets of numbers measuring horizontal and vertical distances. Row and column numbers of pixels from raw imagery are not considered coordinates for the purpose of the standard.

Copyright

Copyright is a legal property right which enables the creator of an original work to protect it from unauthorised use. Through the 1988 Copyright, Designs and Patents Act , Crown copyright continues to subsist in all Ordnance Survey products until the end of the period of 50 years from the end of the year in which they were published, and in the case of data from the end of the year in which it was extracted from the Ordnance Survey database. Crown copyright is vested in The Controller of Her Majesty's Stationery Office, who has delegated powers to the Director General, Ordnance Survey for the administration of copyright in publications and data, including the determination of terms and conditions under which permission for their reproduction is given.

Currency

An expression of the up-to-dateness of data.

Data

A representation of facts, concepts or instructions in a formalised manner suitable for communication, interpretation or processing.

Data Capture

The encoding of data. In the context of digital mapping, this includes map digitising, direct recording by electronic survey instruments and the encoding of text and attributes by whatever means.

Data Format

A specification that defines the order in which data is stored or a description of the way data is held in a file or record.

Data Model

An abstraction of the real world which incorporates only those properties thought to be relevant to the application or applications at hand. The data model would normally define specific groups of **entities** and their **attributes** and the relationship between these entities. A data model is independent of a computer system and its associated data structures. A map is one example of an analogue data model.

Database

An organised, integrated collection of data stored so as to be capable of use in relevant applications, with the data being accessed by different logical paths. Theoretically it is application-independent, but in reality it is rarely so.

Dataset

An Ordnance Survey term for a named collection of logically related features arranged in a prescribed manner. For example, all water features. A dataset has more internal structure than a layer and is related to another dataset only by position.

DDS

Digital Data Storage

Density

A measure of the number of units of data held on a stated length of storage surface. For example some magnetic tapes may be recorded at a density of 1600 bits per inch (bpi). Often referred to as packing density.

Detached Part

A term applying to a part of a Local Government or Parliamentary area which is completely surrounded by other Local Government or Parliamentary areas, and is not connected to the 'parent' area by direct access on the ground.

Digital

Data which is expressed as numbers (digits) in computer readable form is said to be digital.

Digital Map

Any map sold by Ordnance Survey or its agents in any form - i.e. on computer-readable media or as hard copy on paper/film or microfilm - produced mainly, or wholly, using computerised means.

Digital Map Data

The digital data required to represent a map. The data includes not only map detail but also feature header data, map header data and management data.

Digitising

The process of converting analogue maps and other sources to a computer readable form. This may be point digitising, where points are only recorded when a button is pressed on a cursor, or stream digitising where points are recorded automatically at preset intervals of either distance or time as the cursor is traced along a map feature.

Distinctive name

A text feature consisting of text string(s) which form(s) a proper name.

DXF (Drawing Interchange File)

A proprietary data format, devised by Autodesk, by which digital drawings may be transferred between users of CAD (Computer Aided Design) systems. DXF has become an industry standard data format and is used for the transfer of some Ordnance Survey data products.

Eastings

See **Rectangular Coordinates**.

Edge Match

The process of ensuring that data along the adjacent edges of map sheets, or some other unit of storage, matches in both positional and attribute terms.

Entity

Something about which data is stored in a databank or database. For example, building, tree. The data may consist of relationships, attributes, positional and shape information, etc. Often synonymous with feature.

Exabyte

The propriety name for a high density ¼" cartridge tape that will hold up to 2.4 Gb of data. See **Gigabyte**.

Extended Binary Coded Decimal Interchange Code (EBDCDIC)

An 8-bit character encoding scheme.

Extent of the Realm (EOR)

The external bounding lines of Land-Line data is the Extent of the Realm. The Territorial Waters Jurisdiction Act 1878 and the Territorial Waters Order in Council 1964 confirm that the Extent of the Realm of Great Britain as used by Ordnance Survey is properly shown to the limit of Mean Low Water (Mean Low Water Springs in Scotland) for the time being (except where extended by Parliament).

Feature

An item of detail within a map which can be either a point/symbol, a line or text.

Feature Classification Record

A specific, named NTF record which lists the Feature Codes in use in the current database.

Feature Code (FC)

An alphanumeric attribute code used in digital map data to describe each feature in terms of the object surveyed, its representation on the map, or both.

Feature Serial Number (FSN)

A number used as a feature identifier usually allocated on a sequential basis. For example, the order in which features are digitised.

Field

A specific part of a record containing a unit of data, such as the date of digitising. The unit of data may be a data element or a data item. In NTF, a field is a subdivision of a physical record. Every field has a name and a predefined interpretation.

File

An organised collection of related **Records**. The records on a file may be related by a specific purpose, **Format** or data source - the records may or may not be arranged in sequence. A file may consist of records, fields, words, **Bytes**, **Characters** or bits.

Floppy Disc

These are a magnetic medium, generally used in microcomputers (PCs) and come in 5¼" and 3½" sizes.

Font

The style of text character used by a printer or plotter.

Format

The specified arrangement of data. For example, the layout of a printed document, the arrangement of the parts of a computer instruction, the arrangement of data in a **Record**.

Geographical Information System (GIS)

A system for capturing, storing, checking, integrating, analysing and displaying data that is spatially referenced to the Earth. This is normally considered to involve a spatially referenced computer **Database** and appropriate applications software.

Geometric Structure

The ground is modelled in the data as a series of lines and points.

Gigabyte (Gb)

1,073,741,824 bytes; a measure of data storage capacity.

Grid

The planimetric frame of reference. For example, the National Grid.

Hard Copy

A print or plot of output data on paper or some other tangible medium.

Junction

A connection between two or more links at a common node. Junctions may be X-junctions or T-junctions.

Kilobyte (Kb)

1024 bytes; a measure of data storage capacity.

Layer

A subset of digital map data, selected on a basis other than position. For example, one layer might consist of all features relating to roads, and another to railways.

Line

A series of connected coordinated points forming a simple feature with homogeneous attribution.

Line Feature

The spatial abstraction of an object in one dimension. Lines may intersect with other lines. They are defined as a series of two or more coordinates and may be curved or straight. Curved lines consist of a series of very short straight line segments. Lines may be concurrent with other lines under certain conditions. As an object abstraction a line has no width.

Line Segment

A vector connecting two coordinated points.

Linear Feature

Map feature in the form of a line, e.g. road centre-lines, that may or may not represent a real-world feature.

Link

Links are the representation of line features. They are made up of one or more consecutive, non-intersecting, link segments with common attributes, between two terminating nodes. Links have no connection with other links except at the start or end via common (shared) terminating nodes (points). All links contain their terminating coordinates. Links may form the boundaries of polygons and may be shared between polygons. See also **Line**.

Link and Node Data

A form of vector data in which linear features are represented as links. Links are terminated where they intersect other links. These intersection points, and link ends, may carry nodes whose feature records express the geometric relationships between links.

Link and Node Structure

A data structure in which links and nodes are stored with cross-referencing.

Magnetic Tape

This is the traditional data storage and data transfer medium for mainframe computers. It consists of ½" wide magnetic tape on a spool or reel - 2400' length is used by Ordnance Survey. The tape is referred to as 9-Track; 9 bits representing each character are recorded across the tape and whole characters are read as the tape passes the read-head.

Map

The representation on a flat surface of all or part of the earth's surface, intended to be communicated for a purpose or purposes, transforming relevant geographic data into an end-product which is visual, digital or tactile.

Map Generalisation

A reduction in map detail, so that the information remains clear and uncluttered when map scale is reduced. May also involve re-sampling to larger spacing, and/or a reduction in the number of points in a line.

Map Header

Data at the start of the digital map file describing that data. It may contain information on the source and history of the geometric data within the map and the coordinate system in use as well as holding information essential to the management of Ordnance Survey's digital mapping system.

Map Scale

The ratio between the extent of a feature on the map and its extent on the ground, normally expressed as a representative fraction. e.g. 1:1250, 1:50 000.

Megabyte (Mb)

1,048,576 bytes; a measure of data storage capacity.

Name or Text feature

The proper name or label of an object (real-world) or feature (object abstraction) consisting of one or more text strings. A name position is defined by a coordinate pair.

National Grid

A unique referencing system which can be applied to all Ordnance Survey maps of Great Britain (GB) at all scales. It is based on 100 km squares covering the whole of GB based on a Transverse Mercator Projection. It is used by Ordnance Survey on all postwar mapping to provide an unambiguous spatial reference in GB for any place or entity whatever the map scale.

National Transfer Format (NTF)

A format designed in 1988 specifically for the transfer of spatial information; it is published as British Standard BS 7567 and is administered by the Association for Geographic Information. It is now the standard transfer format for Ordnance Survey digital map data.

Node

An object representation of a point which either does not form any part of a link (isolated node or polygon seed point); or is the representation of a point at the start or end of a link (terminating node). The position of a node is defined by a single coordinate pair - which is repeated within all links logically connected at that node and/or containing it. A node is only deleted if the link containing it as a terminating node is deleted.

Northings

See **Rectangular Coordinates**.

Orientation

Orientation of a point or a text feature is measured in degrees anticlockwise from Grid East.

Origin

The zero point in a system of **Rectangular Coordinates**.

Packing

Spaces used as fillers to complete a record or field.

Pecked Line

A line drawn as a series of dashes.

Physical Record

A physical record may be fixed length containing 80 characters, or variable length containing **up to** 80 characters.

Point

A zero-dimensional spatial abstraction of an object represented as a coordinate pair.

Point and Line Data

A form of vector data designed for map production in which all map features are designated as points, lines or text. Point and line data does not carry the topological relationships between features.

Point Feature

A zero-dimensional spatial abstraction of an object with its position defined by a coordinate tuple. Points are represented by nodes which may be isolated or part of a link (terminating). Points may also be represented by symbols which may have attributes such as rotation and size.

Polygon

Polygons are a representation of areas. A polygon is defined as a closed line or perimeter completely enclosing a contiguous space and made up of one or more links. At least one node occurs on the perimeter of a polygon where the bounding link completes the enclosure of the area. There may be many nodes connecting the bounding links of a polygon. Links may be shared between polygons. Polygons may wholly contain other polygons, or be contained within other polygons. Each may contain a single isolated node (seed point) which identifies the polygon.

Polygon Boundary

The link or links which enclose a polygon, projected into the horizontal plane.

Polygon Point

A polygon seed.

Polygon Seed

See **Seed**.

Positional Accuracy

The degree to which the coordinates define a point's true position in the world, directly related to the spheroid/projection on which the coordinate system is based.

Precision

The exactness with which a value is expressed, whether the value be right or wrong.

Record

A set of related data fields grouped for processing.

Recording Format

The logical and/or physical levels of the protocol governing the laying down of data on the physical transfer medium.

Rectangular Coordinates

Also known as X-Y **Coordinates** and as **Eastings** and **Northings**. These are two-dimensional coordinates which measure the position of any point relative to an arbitrary origin on a plane surface, e.g. a map projection, a digitising table, a VDU screen.

Resolution

A measure of the ability to detect quantities. High resolution implies a high degree of discrimination but has no implication as to **Accuracy**. For example, in a collection of data in which the **Coordinates** are rounded to the nearest metre, resolution will be 1 m but the accuracy may be ± 5 m or worse.

Section

In NTF terminology, a subdivision of a database. In Ordnance Survey terms this equates to a single map sheet, i.e. a digital map file or a tile.

Seed

A seed is a digitised point within an area, usually a defined polygon, e.g. lake or woodland, but not always, e.g. a geographical seed, such as the South Downs.

Seed Point

A coordinated point within a polygon to which alphanumeric information may be attached.

Segment

A chord defined by two consecutive **Coordinates** in a line string.

Source Scale

The scale of the source information from which the map was digitised, i.e. the scale of survey for a Basic Scale Map, or the scale of the source map for a Derived Map.

Spatial Data

Data which includes a reference to a two- or three-dimensional position in space as one of its attributes. It is used as a synonym for geometric data.

Structured data

Data within which collections of features - of any type - form objects. Topographically structured data also contains topological information defining the relationships between features and objects.

Terminator

A character, character string, field or record used to signal the end of a record, section, volume or database.

Text Coordinates

Each text feature has a 'start-of-text' coordinate which is digitised.

Text Feature

A free standing text string in the digital data describing a feature, or particular instance of a feature, e.g. Factory, Acacia Avenue.

Text Height

The height at which a text string is intended to be plotted out at the nominal map scale. This information is included in the feature header of the text feature.

Text Position

See Text Coordinates. Also known as Original Digitising Position.

Tile

Broadly synonymous with digital map file, it implies evenly sized map sheet units.

TK50

A data cartridge for use with Digital Equipment Corporation (DEC) hardware.

Topographic Database

A database holding data relating to physical features and boundaries on the Earth's surface.

Topography

Topography is the study of the physical features of the Earth. A topographic map's principal purpose is to portray and identify the features of the Earth.

Topology

The study of the properties of a geometric figure which are not dependent on position, such as connectivity and relationships between lines, nodes and polygons.

Transfer Format

The format used to transfer data between computer systems. In general usage this can refer not only to the organisation of data, but also to the associated information, such as attribute codes, which are required in order to successfully complete the transfer.

Transfer Medium

The physical medium on which digital data is transferred from one computer system to another. For example, magnetic tape.

Transfer Set

A specific NTF term for the data, together with its supporting information, which the customer receives.

UNIX

An operating system that supports multi-tasking and is used by many workstations and minicomputers.

Update

The process of adding to and revising existing digital map data to take account of change.

Vector

A straight line joining two data points.

Vector Data

Positional data in the form of coordinates of the ends of line segments, points, text positions, etc.

Volume

A physical unit of the transfer medium, that is, a single disc, a single cartridge or a single tape.

Appendix D Terms and Conditions

The following give a brief guide to the terms and conditions of supply and use of Meridian. A full description is detailed in the signed customer contract held by your organization.

Use of Meridian

Meridian is supplied under single payment license, valid for five years and includes copyright royalties

The fee includes a customer-use factor (charge band) and the right to make up to 5 000 hard copies per year for agreed internal business use.

Delivery of Meridian

Customers are advised to copy the supplied data to a back-up medium.

Written notification of any deficiency in the data or damage to the goods must be given to Ordnance Survey within 28 days of receipt of Meridian.

Invoice

Payment in full, of the amount shown on the invoice, is due 30 days after the invoice date. The only exception is where Ordnance Survey have agreed extended terms with a customer.

Copyright

All Ordnance Survey Digital Map Data are Crown copyright. Full details of the conditions under which Ordnance Survey Digital Map Data may be processed/manipulated or copied by a customer – whether or not for use on visual terminals or for making hard copies – are contained in Ordnance Survey leaflet: *Copyright 3 - Digital Map Data*. These are available from Copyright, please see below. Users should check the terms and conditions with Ordnance Survey before using the data. It is also the responsibility of the holder of the Digital Map Data to ensure that any output contains the required copyright acknowledgement.

No part of this document may be reproduced or transmitted in any form or by any means, electronic or mechanical, for any purpose, without the express written permission of Ordnance Survey.

© Crown copyright Reserved

Copyright
Ordnance Survey
Romsey Road
SOUTHAMPTON
SO16 4GU

Telephone 01703 792684
Fax 01703 792535

Appendix E Product Performance Report Form

Please photocopy and send completed to:

Ordnance Survey
Senior Product Manager Meridian Team
Romsey Road
SOUTHAMPTON
SO16 4GU

Problem description/suggestion for:

.....
.....
.....
.....
.....
.....
.....
.....
.....

Quotation/Order Ref:

Your Name:

Company:

Address:

.....

.....

.....

.....

Tel:

Fax:

Meridian

User Guide

Format Section

Chapter 1 Introduction

The purpose of this Format Section is to:

- Provide a brief description of the presentation of Meridian in the two transfer formats in which it is supplied:
 - BS 7567 (NTF v2.0 Level 3)
 - Drawing Interchange File (DXF) (conforming to AutoCAD release 12 with Extended Entity Data)

As part of this description, Data Structure diagrams are used to give greater explanation where necessary

- Provide Licenced System Suppliers with as much detail as necessary to enable Meridian files in either NTF or DXF to be easily understood and processed by application software.

The term 'Data Structure' used in this Format Section refers to the organisation and sequence of the records in the data file and NOT to the geographical topology of the data.

Because of the fundamental differences in the data format of Strategi supplied in NTF and DXF, this section devotes separate chapters to these transfer formats for the following aspects:

- General explanation of file format
- Data structure.

In other chapters where there is a need to be specific about one format the relevant text is highlighted. The following is an example of the style used in these circumstances.



For convenience, BS 7567 (NTF v2.0 Level 3) is referred to as NTF in this Section.



Drawing Interchange File (DXF) is referred to as DXF in this Section. Complies with BS 1192 Part 5 Guide for structuring of computer graphic information.

This Section should be read in conjunction with the Meridian Reference Section which describes the content of Meridian.

Meridian General Specifications

The following gives details of the product specification identity and their relationship to Ordnance Survey data capture specifications. Version details of these specifications are also stated.

| Product | Product Specification |
|----------------|------------------------------|
| Meridian | Meridian_01.95 |

Transfer Format Specifications:

| | | |
|------------|--------------------|-----------------|
| Name | BS 7567 (NTF v2.0) | DXF |
| Level | 3 | |
| Version | 2 | 1 |
| Issue Date | 15 May 1992 | 01 January 1997 |

Chapter 2 Introduction to Data Formats

NTF

Data supplied in this format has variable length records. An overview of the data format of a Meridian file in NTF is shown over the page. The convention used for diagramming data files is the industry standard adopted for Jackson Structured Programming (JSP).

Jackson Structure

The following diagrams are examples of Meridian files and no fixed record sequence or relationship is implied.

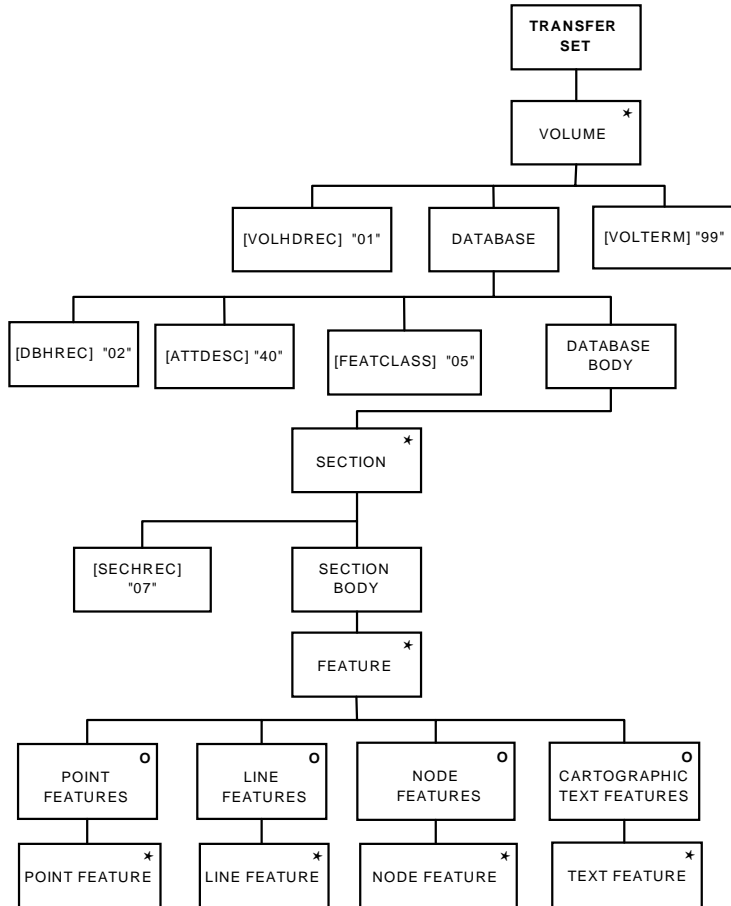

Key:
 * One or more
 O Selection

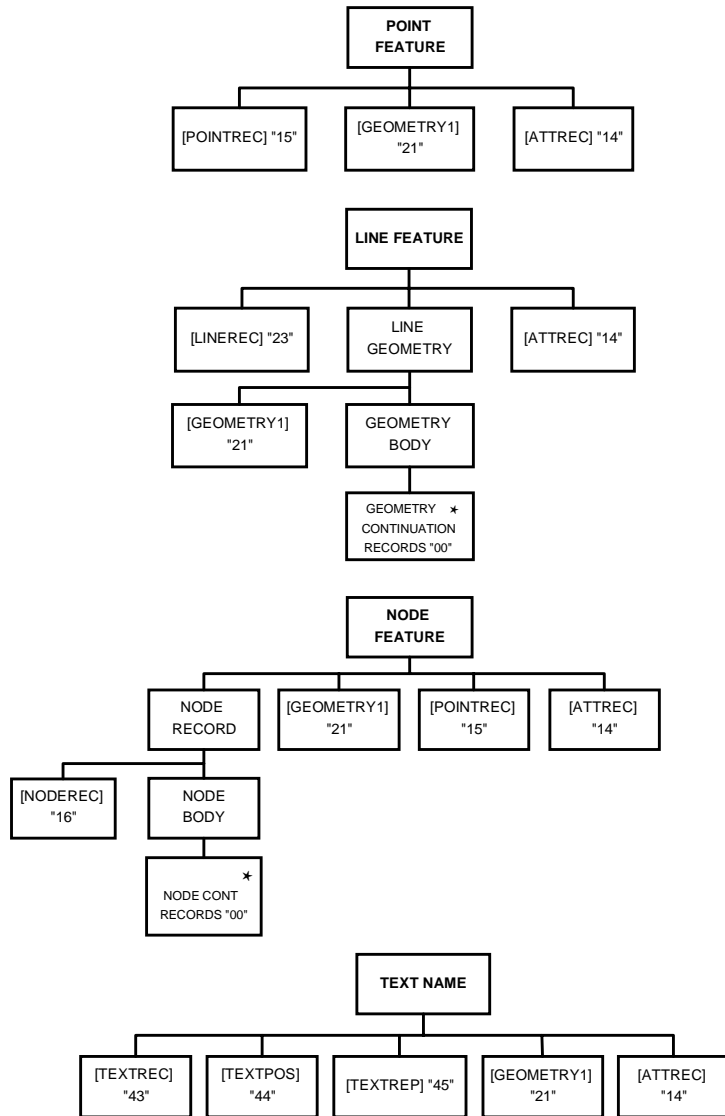

Key:
 * One or more

Drawing Interchange File (DXF)

Meridian is available in DXF Level 1, conforming to AutoCAD release 12 using Extended Entity Data to store attributes. The transfer format is that defined by the NEDO Working Party for the exchange of two-dimensional drawings in the construction industry. An overview of the data structure of a Meridian file in DXF is shown below.

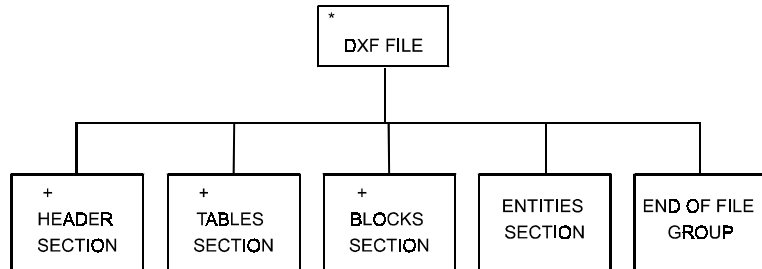

Key:

* = One or more

+ = Optional

Chapter 3 NTF Explained

Meridian data is supplied in the British Standard national format common to all Ordnance Survey's digital map data products; namely NTF, and is transferred in Level 3 as variable length records. An overview of the data structure of a Meridian data file is shown in diagrammatic form in Chapter 2 of the Format Section. The convention used for this diagram is in the industry standard adopted for Jackson Structured Programming (JSP).

The British Standard for NTF stipulates the following for Level 3: This level supports a variety of data models that may include network data, polygons, semantic relationships and complex features - for example, a school consisting of its buildings, boundaries and playing fields.

This level is designed for:

- Transferring basic geometry and simple features through the use of geometry and feature records
- Relating basic geometrical and topological elements to one or more features through the use of chain, polygon and complex line records
- Combining features to form complex features through the use of collection and complex polygon records
- Using text records both to relate text strings to features and cartographic output
- Referencing and positioning external features, for example, raster data.

The record structure at this level may also be defined to be compatible with data in Levels 1 and 2.

The colour and line weights of some layers may differ when DXF is used with certain software packages.

The governing body for the industry standard NTF is the Association for Geographic Information (AGI).

Their address is as follows:

The Association for Geographic Information
c/o The Royal Institution of Chartered Surveyors
12 Great George Street
Parliament Square
LONDON
SW1P 3AD

Telephone: 0171 222 7000

Any queries relating to the Meridian product should be referred to Customer Services - Digital Help Desk at the address given in Contact Details at the beginning of this User Guide.

Chapter 4 DXF Explained

Introduction

This chapter describes the representation of Meridian in Ordnance Survey's implementation of DXF. Meridian is supplied to the Product Specification Meridian_01.95

Overview

Structure of Meridian

Meridian has a limited 'Link and Node' data structure; within this structure a feature may be a name, a point, or a line (or series of lines forming a coherent unit). Each feature is free standing; that is, its topological relationship to any other feature is NOT expressed in the data.

Features are classified by type and each type is placed in a separate DXF layer.

Line Features

A feature is a subjective entity; that is, so long as the constituent lines are of the same description (layer), a feature need not fully describe a logical piece of detail.

The extent of a feature is determined by digitising conventions and does not always coincide with the topology. Each linear feature is composed of a string of XY coordinate pairs implicitly joined by straight lines.

The colour and line weights of some layers may differ when DXF is used with certain software packages.

Area Features

Area features are not defined within vector link and node data. Features which might be thought of as area features are treated in the data as linear features, e.g. a developed land use area boundary is treated as a polyline in layer G8056300.

Name Features

Name features are treated as free standing text data. There is no explicit relationship (in the data) between a text feature and the point or line feature to which it belongs.

Ordnance Survey distinguishes between layer name types, for example Place Names and Station Names - by placing each name type in a separate DXF layer.

Text has position, expressed as a single coordinate pair, held as X and Y offsets from the map origin (SW corner). Text which is double or treble banked is treated as two or three separate features. The text string may be considered to be contained within an 'envelope' whose bottom left hand corner is positioned on this coordinate pair. Text is oriented, that is, it may run from west to east across the map, or it may be plotted at some other angle measured anti-clockwise from grid east.

Drawing Content and Format

Coordinate System

The coordinate system is National Grid, (NG).

The NG coordinates are to a resolution of 0.01 metre. This is the resolution of the source data.

Height

No height attributes are applied to any feature.

Layer Names

British Standard 1192 Part 5, (Guide for structuring of computer graphic information) has been adopted.

Each layer name is an eight character string. The first four characters relate to the AUG/Autodesk system, with G (GIS) as the source of the information, and 800-899 as the part code. This product is **G805**.

The remaining four digits relate to existing Ordnance Survey Digital Map Data in their own NTF system and are leading zero filled.

For example:

G8056001 - Motorways

Neatline

Neatlines around the extent of the map data are added as lines in the ENTITIES section, (layer name G8050572).

Grid

A grid is added as lines in the ENTITIES section (layer name G8050572). The grid is created by the translator and therefore must be specified before the translation takes place.

Grid Values

Full 100 000 metre National Grid Easting and Northing values followed by an 'm' are added as text strings in the ENTITIES section, (layer name G8050573) at each corner of the map extent either horizontal or vertical to read from the lower left corner of the tile.

Intermediate grid values are shown as multiples of 1000 metres from the nearest 100 km National Grid, (layer name G8050572). These are horizontal.

DXF Layers

Ordnance Survey categorises map features into layers, the number of layers depends on the specific map content and the product specification.

| Layer Name | Description | Linetype | Line Weight | Entity | Block | Colour |
|------------|---------------------|------------|-------------|----------|--------|----------------|
| G8056001 | Motorway | CONTINUOUS | 3 | POLYLINE | BLUE | |
| G8056041 | A road | CONTINUOUS | 1 | POLYLINE | RED | |
| G8056061 | B road | CONTINUOUS | 1 | POLYLINE | ORANGE | |
| G8056080 | Minor road | CONTINUOUS | 1 | POLYLINE | WHITE | |
| G8056700 | Road node | DOT | | INSERT | GREEN | CIRCLE (small) |
| G8056701 | Road edge node | DOT | | INSERT | GREEN | CIRCLE (small) |
| G8056140 | Railways | CONTINUOUS | 3 | POLYLINE | WHITE | |
| G8056142 | tunnelled railway | DASHED | 1 | POLYLINE | WHITE | |
| G8056155 | station | DOT | | INSERT | RED | CIRCLE |
| G8056730 | railway node | DOT | | INSERT | GREEN | CIRCLE (small) |
| G8056731 | railway edge node | DOT | | INSERT | GREEN | CIRCLE (small) |
| G8056401 | County boundary | DASHDOT | 1 | POLYLINE | GREEN | |
| G8056403 | District boundary | DASHED | 1 | POLYLINE | GREEN | |
| | /London Borough | | | | | |
| | /Unitary Authority | | | | | |
| G8056405 | County/District | DASHDOT | 1 | POLYLINE | GREEN | |
| | /LB/UA boundary | | | | | |
| G8056800 | Boundary neat line | CONTINUOUS | 1 | POLYLINE | GREEN | |
| G8056411 | County seed | CONTINUOUS | | INSERT | GREEN | SEEDPOINT |
| G8056415 | District seed | CONTINUOUS | | INSERT | GREEN | SEEDPOINT |
| G8056710 | Boundary node | DOT | | INSERT | GREEN | CIRCLE |
| G8056711 | Boundary edge node | DOT | | INSERT | GREEN | CIRCLE |
| G8056200 | Coastline | CONTINUOUS | 1 | POLYLINE | BLUE | |
| G8056740 | Coastline node | DOT | | INSERT | GREEN | CIRCLE |
| G8056741 | Coastline edge node | DOT | | INSERT | GREEN | CIRCLE |

| Layer Name | Description | Linetype | Line Weight | Entity | Block | Colour |
|------------|-----------------------|------------|-------------|-----------|-------|--------------|
| G8056300 | DLUA boundary | CONTINUOUS | 2 | POLYLINE | GREY | |
| G8056310 | DLUA seed | CONTINUOUS | | INSERT | GREY | DLUASEED |
| G8056720 | DLUA node | DOT | | INSERT | GREEN | CIRCLE |
| G8056721 | DLUA edge node | DOT | | INSERT | GREEN | CIRCLE |
| G8056801 | DLUA neat line | CONTINUOUS | 1 | POLYLINE | GREY | |
| G8056500 | Place name | STANDARD | | TEXT | WHITE | |
| G8056551 | Station name | STANDARD | | TEXT | WHITE | |
| G8050575 | Default | CONTINUOUS | 1 | POLYLINE | WHITE | |
| G8050571 | Footnotes | STANDARD | | INSERT | WHITE | ME_FOOTNOTES |
| G8050572 | Grid lines and values | CONTINUOUS | 1 | LINE/TEXT | WHITE | |
| G8050573 | Grid values | STANDARD | | TEXT | WHITE | |

Footnotes

The following footnotes are added as an insert BLOCK in the ENTITIES section of the DXF data file. The positions of the footnotes are indicated in Figure 4.1.

Note 1: Top Margin centrally aligned, 700 ground metres,
Layer: G8050571

Ordnance Survey®

Note 2: Top Margin centrally aligned, 600 ground metres,
Layer: G8050571

Meridian™ Data

Note 3: Lower left margin, 200 ground metres,
Layer: G8050571

Translation Date dd Mmmmmmmmm CCYY

Note 4: Lower left margin, 200 ground metres,
Layer: G8050571

Tile reference number __ __ __

Note 5: Lower left margin, 200 ground metres,
Layer: G8050571

Reproduced from Ordnance Survey Meridian™ data with the permission of the controller of Her Majesty's Stationary Office.

© Crown Copyright CCYY

Note 6: Lower right margin, 200 ground metres,
Layer: G8050571

The derived scale of the product is dependent upon the source data.

Note 7: Lower right margin, 200 ground metres,
Layer: G8050571

The representation of a road, track or path is no evidence of a right of way.

The alignment of tunnels is approximate.

Note 8: Lower right margin, 200 ground metres,
Layer: G8050571

Date of last amendment dd Mmmmmmmmm CCYY

Note 9: Lower right margin, 200 ground metres,
Layer: G8050571

Product specification Meridian_01.96

Figure 4.1: Layout of Footnotes

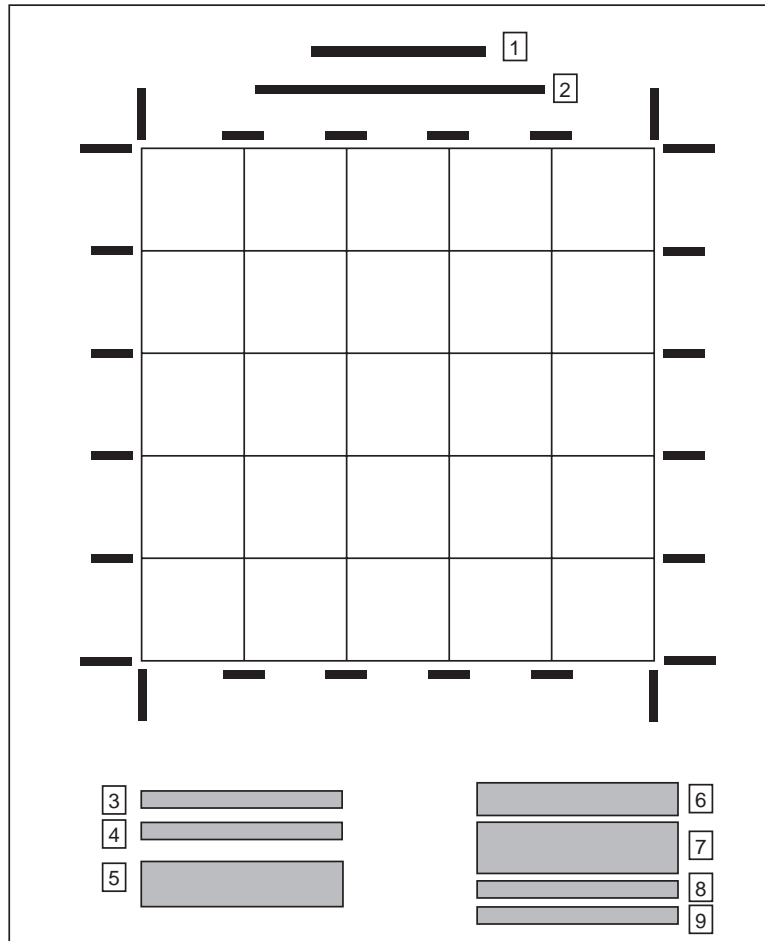

Appendix A NTF File Structure for Meridian

An Overview of the Data in NTF

The following section gives a detailed breakdown of the data structure of Meridian in NTF.

This is a two stage procedure which consists of:

1. Outline description of the data structure
2. Record breakdown.

There are certain conventions used in the record examples, which are:

- [] Square brackets are placed around record names, e.g. [VOLHDREC].
- { } A pair of braces denote field names, e.g. {REC_DESC} is the Record Descriptor Field.
- [] 90 A two-digit number following square brackets denotes the Record Descriptor which uniquely identifies the record name between the brackets.
- <S> This is the space character (ASCII code 32).
- <3S> This denotes three successive space characters.
- % The percentage character (ASCII code 37).

Outline Description of the Data Structure

Record Size

NTF data is written to the output device in variable length records, with a maximum record length of 80 characters, which includes {CONT_MARK} and {EOR}.

Record Terminator {EOR}

The end of record terminator is the percent (%) (ASCII 37) character for both formatted and unformatted media.

Transfer Set

A transfer set normally equates to a single file except where continuation volumes are used when the transfer set exceeds the capacity of the media. The data the customer receives is in one or more Transfer Sets. Each Transfer Set starts with a Volume Header Record [VOLHDREC] and terminates with a Volume Terminator Record [VOLTERM].

Supply of Data on Unformatted Media

The Transfer Set normally has one dataset with one or more sections.

Continuation volumes are only used if a section is larger than the capacity of the medium.

A customer's order that is larger than the capacity of the medium, is split into two or more Transfer Sets.

As the block length is 2000 bytes and the record length is variable it cannot be determined how many records are in each Data Block. Records do not span Data Blocks, so any space left at the end of a Block is filled with Null Records - where a Null Record is between 0 to 79 spaces (ASCII 32), terminated by % (ASCII 37).

Unformatted media

| | |
|----------------------------------|----|
| 01 VOLUME HEADER RECORD | 01 |
| 02 DATABASE HEADER RECORD | |
| 40 ATTRIBUTE DESCRIPTION RECORD | |
| 05 FEATURE CLASSIFICATION RECORD | |
| 07 SECTION HEADER RECORD | |
| Tile 1 data | |
| 07 SECTION HEADER RECORD | |
| Tile 2 data | |
| 07 SECTION HEADER RECORD | |
| etc. | |
| 99 VOLUME TERMINATION RECORD | |

* '99End Of Transfer Set 0%'

Magnetic tape output is terminated by two Tape Marks.

Supply of Data on Formatted Media

Data requested on floppy disk (5¼" or 3½"), UNIX cartridge or other logically formatted media, as defined by current Ordnance Survey product specifications, is not blocked but is written directly to the output device.

The Transfer Set has one dataset and one section. One or more Transfer Sets are put onto the medium.

A customer's order that is larger than the capacity of the medium, is put onto two or more of that media.

Continuation volumes are only be used if a Transfer Set is larger than the capacity of the medium.

Formatted media (Transfer Set less than media capacity)

| | |
|----------------------------------|----|
| 01 VOLUME HEADER RECORD | 01 |
| 02 DATABASE HEADER RECORD | |
| 40 ATTRIBUTE DESCRIPTION RECORD | |
| 05 FEATURE CLASSIFICATION RECORD | |
| 07 SECTION HEADER RECORD | |
| Tile 1 data | |
| 99 VOLUME TERMINATION RECORD | |
| * | |
| 01 VOLUME HEADER RECORD | 01 |
| 02 DATABASE HEADER RECORD | |
| 40 ATTRIBUTE DESCRIPTION RECORD | |
| 05 FEATURE CLASSIFICATION RECORD | |
| 07 SECTION HEADER RECORD | |
| Tile 2 data | |
| 99 VOLUME TERMINATION RECORD | |
| * | |
| etc. | |
| Tile n data | |
| 99 VOLUME TERMINATION RECORD | |
| * | |

* '99End Of Transfer Set 0%'

Formatted media (Transfer Set greater than media capacity)

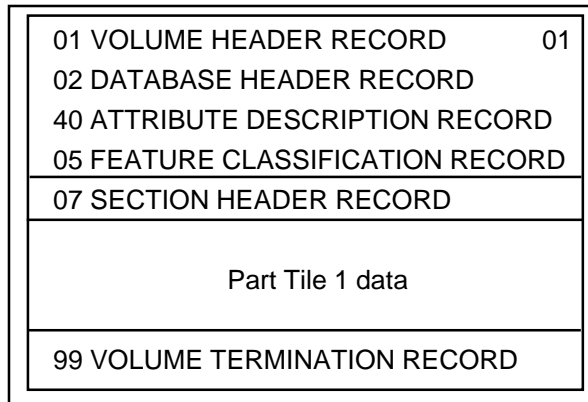

**

** '99 End Of Volume 01 Transfer Set Continues On
Volume 021%'

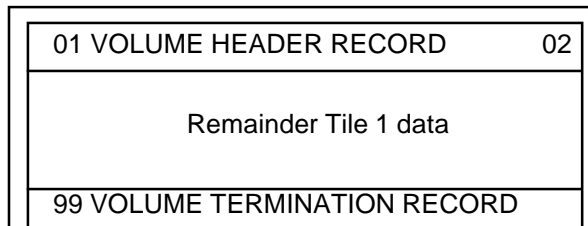

*

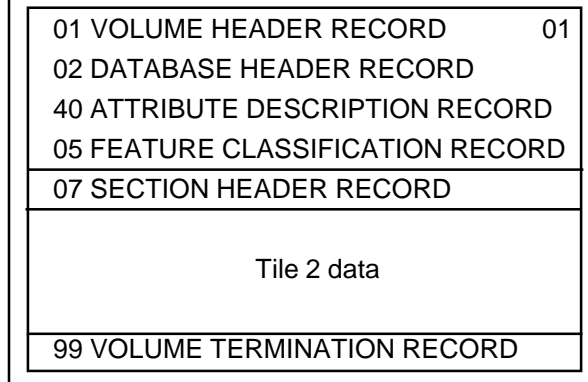

*

* '99End Of Transfer Set 0%'

The beginning of each Transfer Set is structured with the following 'introductory', or 'leading', records:

Database Header Record [DBHREC]: this gives details of:

1. The Database Name
2. NTF Release Date
3. Feature Classification Table Name
4. Release date which applies to the whole of the Transfer Set.

Attribute Description Record [ATTDESC]: this lists and gives a description of the Attributes that can be applied to features within the Transfer Set.

Feature Classification Record [FEATCLASS]: this lists and gives descriptions of all possible Feature Codes for the Transfer Set.

These 'introductory' records are followed by the data requested by the customer, which are contained in the section.

The section consists of two parts:

1. **Section Header Record [SECHREC]:** this gives the National Grid coordinates of the section and on unformatted media informs the customer that a new section is starting.
2. **Section Body:** this comprises all the features within the section.

Version Management

Each version and release of all Meridian products are defined by a unique Product Version number and Release number - these are reflected in this User Guide. The Product Version number relates to the specification of the data being supplied, and the Release number relates to the release of the product.

The **Product Version number** takes the form **xx.yy**, where xx is the major product number, and yy is the minor change number. Thus version 02.04 would indicate that this is the major product version 02, and that this is the fourth minor amendment to the product specification.

The **Release number** takes the form **xx.yy**, where xx is the sequential release within a year, and yy is the year of the release. Thus release 02.94 would indicate that this is the second data release in 1994.

The Product Version number and the Release number are specified in the Database Header Record [DBHREC], as supplied in NTF.

General

The following are the Record definitions for the transfer of Meridian data in NTF:

- Volume Header Record [VOLHDREC]
- Database Header Record [DBHREC]
- Feature Classification Record [FEATCLASS]
- Attribute Description Record [ATTDESC]
- Section Header Record [SECHREC]
- Section Body - see Point and Line Features
 - Name Detail
 - Node Detail
- Volume Terminator Record [VOLTERM]

Section Body

This comprises all the features within the tile that correspond to the feature types selected by the customer.

Point and Line Features

Point Feature

Each point feature is depicted by the use of the following Records:

| | <u>Description in NTF</u> |
|------------------|---------------------------|
| POINT RECORD | [POINTREC] |
| GEOMETRY RECORD | [GEOMETRY1] |
| ATTRIBUTE RECORD | [ATTREC] |

Line Feature

Each line feature is depicted by the use of the following Records:

| | <u>Description in NTF</u> |
|-------------------------------------|---------------------------|
| LINE RECORD | [LINEREC] |
| GEOMETRY RECORD | [GEOMETRY1] |
| GEOMETRY CONTINUATION RECORDS | |
| ATTRIBUTE RECORDS | [ATTREC] |

Geometry Records

Geometry Records contain the coordinate position(s) in metres of the feature. Point features contain one coordinate pair; line features contain 2 or more coordinate pairs. Geometry Continuation Records are used where required. {X_COORDS}, {Y_COORDS} and {QPLAN} are treated as separate fields.

Name Detail

Each cartographically positioned name is depicted by the use of the following Records:

| | <u>Description in NTF</u> |
|----------------------------|---------------------------|
| TEXT RECORD | [TEXTREC] |
| TEXT POSITION RECORD | [TEXTPOS] |
| TEXT REPRESENTATION RECORD | [TEXTREP] |
| GEOMETRY RECORD | [GEOMETRY1] |
| ATTRIBUTE RECORD | [ATTREC] |

Records

Text details are only given when a name has been cartographically positioned. The Attribute Record [ATTREC] contains the definitive name is pointed to by the Text Record [TEXTREC].

The Text Record points to the Attribute Record and also points to the Text Position Record [TEXTPOS].

The Text Position Record refers back to the Text Record and points to the Geometry Record containing the coordinates of the digitised position. The Text Position Record also points to the Text Representation Record [TEXTREP] which contains the standard digitising position and orientation of the text.

All other names are held as Attributes only.

Node Detail

Node Feature

Each node feature is depicted by the use of the following Records:

| | <u>Description in NTF</u> |
|------------------|---------------------------|
| NODE RECORD | [NODEREC] |
| NODE | |
| CONTINUATION | |
| RECORD | |
| GEOMETRY RECORD | [GEOMETRY1] |
| POINT RECORD | [POINTREC] |
| ATTRIBUTE RECORD | [ATTREC] |

All links in Meridian terminate in explicit node records; each node is related to a point and its attributes via a common geometry record. This structure allows an attribute with a node within the constraints of NTF.

Records

Node Record transfers details of the bearings and number of lines that meet at a point or node.

The Node Record contains references to each Line Record that meets at that Node and to the Geometry Record. The Geometry Record is referenced by the Point Records containing the feature attributes of the Node.

Where lines do not meet at a previously specified Point feature, a special Point feature is created.

The Node Record can contain details of up to 5 Line features that meet at a node. Further lines meeting at that node are written to the Node Continuation Record.

It is important to note that, although the Node Record contains references to its appropriate Point and Line features, the Point and Line features do not contain references to the Node.

Feature Information Relevant to NTF

Point Features

Point features can exist independently and at the junction or ends of lines. The point feature gives a position and attribute to the corresponding node.

Line Features

All line features, with the exception of where railways cross at different levels, are broken when they intersect one another within a layer. *Note: a layer is a subset of digital map data, selected on a basis other than position. For example, one layer might consist of all features relating to roads, and another to railways.*

The first and last coordinate pairs in a line correspond exactly with the start or end coordinates of any adjoining line(s).

A line cannot cross from one tile (20 km by 20 km square) to the next - it is split on the tile edge, but see Unique Identifiers.

All linear features are continuous. Cartographic gaps are closed during the digitising process.

Coordinates

Coordinate values and the number of coordinate pairs in a feature are transferred in the [GEOMETRY1] NTF record.

All coordinates within the data are expressed as strings of five numeric characters. Leading zeros are present to complete the five characters.

All coordinates are measured from the local origin, which is the south-west corner of the tile.

To convert coordinate data to full National Grid coordinates, add the coordinates of the feature to those of the south-west corner of the tile. The south-west corner coordinates are contained within the {X_ORIG} and {Y_ORIG} fields of the Section Header Record ([SECHREC] '07').

Bearings

Bearings are transferred in the {ORIENT} field of the Node Record ([NODEREC] '16').

Bearings are National Grid Bearings, in degrees, measured clockwise from Grid North.

The start of line bearing, indicated by a value of '1' in the {DIR} field of [NODEREC], is the bearing of the first segment of the line. The direction is from the start of the line to the next pair of coordinates or, if there are only two coordinate pairs, from the start to the end of the line.

The end of line bearing, indicated by a '2' in the {DIR} field, is the bearing of the last segment of the line. The direction is from the end of the feature to the last-minus-one pair of coordinates.

Attribute Codes

Attribute Codes provide supplementary information on a feature, providing such qualifying information as Feature Code, Feature Name, Orientation, etc.

In NTF, the structure of user defined Attributes is described in record '40' - [ATTDESC].

The actual Attribute detail of a record is written in record '14' - [ATTREC].

Attributes which are used in the supply of Meridian data are:

- FC **Feature Code.** Contains the numeric Feature Code of the feature.
- OM **OSMDR.** A unique identifier for links and nodes on road features.
- RN **Road Number.** Department of Transport route number.
- TR **Trunk Road** indicator.
- RT **Roundabout** indicator.
- JN **Junction Name.** The name of a road junction.
- LC **Left County** boundary indicator.
- RC **Right County** boundary indicator.
- LD **Left District*** boundary indicator.
- RD **Right District*** boundary indicator.
- PI **Global Id.** A unique identifier for administrative areas.
- DA **DLUA Id.** A unique identifier for a developed land use areas.
- PN **Proper Name.** The definitive name for a developed land use area or railway station.
- RI **Rail Id.** A unique railway link identifier.
- SI **Station Id.** A unique railway station identifier.
- NM **Admin Name.** An administrative area name.
- TX **Text.** Independent text.

* Includes London Borough and Unitary Authority Area

Unique Identifiers

Unique Identifiers are used to uniquely identify some features within Meridian. These are:

- **Ordnance Survey Meridian Database Reference (OSMDR).** This uniquely identifies any road link or road node within the national Meridian database and is compatible with the OSCAR family of products. Interchange of data between Meridian and OSCAR is possible with software modification.
- **Railway and Railway Station Identifiers.** These uniquely identify any railway link or railway station within the national Meridian database.
- **Developed Land Use Area Identifier.** This uniquely identifies any developed land use area seed point within the national Meridian database.
- **Global Identifier.** This uniquely identifies any administrative area seed point within the 20 km by 20 km tile.

The Unique Identifiers are unique references and are maintained, except where there has been significant change to a feature.

The Unique Identifier may refer to several links representing a linear object across tiles, e.g. a road or a railway, which may be chained together across tile edges. Thus, on adjoining tiles, there may be two or more links with the same Unique Identifier, see Figures A.1 and A.2.

Record IDs

The identifying fields for each NTF record - e.g. NODE_ID for [NODEREC], LINE_ID for [LINEREC], etc. - are unique within each individual section (tile) supplied. They are not maintained between supplies.

Figure A.1: Example of a Unique Identifier - OSMDR

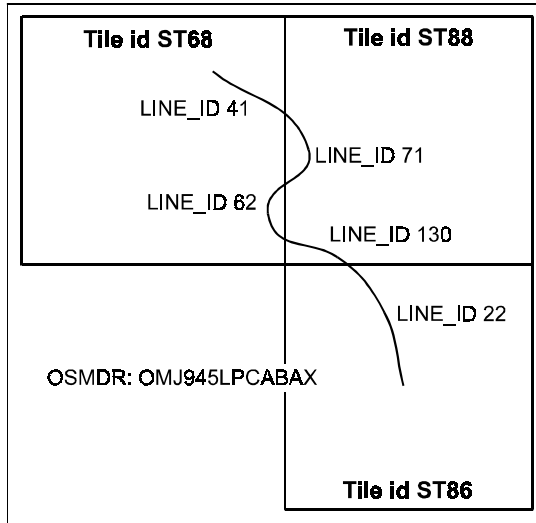
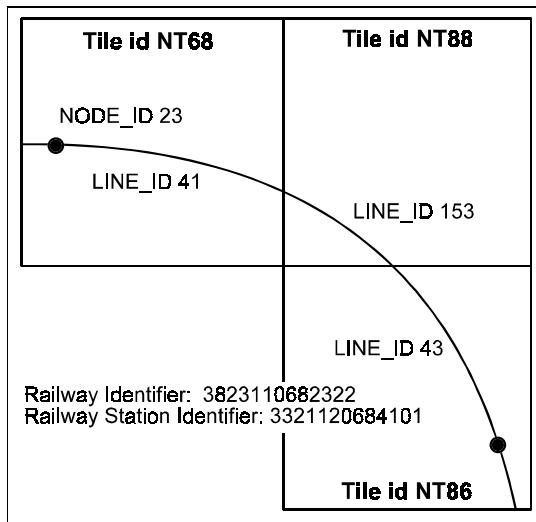

Figure A.2: Example of Unique Identifier - Railway and Railway Station



Feature Layers

This section contains a list of all the valid features used with Ordnance Survey's Meridian. The list contains a description of each feature, its Feature Type, its Feature Code and a list of the Attributes, other than FC, which can be associated with that feature. The list is segmented by Feature Layer. *Note: all features carry the Attribute FC as the Feature Code.*

| Feature Description | Type | Code | Attribute(s) |
|---|-------|------|----------------|
| Roads | | | |
| Motorway | Line | 6001 | OM, RN, TR |
| A road | Line | 6041 | OM, RN, TR |
| B road | Line | 6061 | OM, RN, TR |
| Minor road | Line | 6080 | OM, TR |
| Road node | Point | 6700 | OM, JN, RT |
| Road edge node | Point | 6701 | |
| Railways | | | |
| Railway | Line | 6140 | RI |
| Tunnelled railway | Line | 6142 | RI |
| Railway station | Point | 6155 | SI, PN |
| Railway node | Point | 6730 | |
| Railway edge node | Point | 6731 | |
| Administrative Areas and Coastline | | | |
| County boundary | Line | 6401 | LC, RC |
| District* boundary | Line | 6403 | LD, RD |
| County/district* boundary | Line | 6405 | LC, RC, LD, RD |
| Neat line | Line | 6800 | LC, RC, LD, RD |
| County seed | Point | 6411 | PI, NM |
| District* seed | Point | 6415 | PI, NM |
| Boundary node | Point | 6710 | |
| Boundary edge node | Point | 6711 | |
| Coastline | Line | 6200 | LC, RC, LD, RD |
| Coastline node | Point | 6740 | |
| Coastline edge node | Point | 6741 | |

* Includes London Borough and Unitary Authority Area

| Feature Description | Type | Code | Attribute(s) |
|--|-------------|-------------|---------------------|
| Developed Land Use Areas (DLUA) | | | |
| DLUA boundary | Line | 6300 | |
| DLUA seed | Point | 6310 | PN, DA |
| DLUA node | Point | 6720 | |
| DLUA edge node | Point | 6721 | |
| Neat line | Line | 6801 | |
| Cartographic Names | | | |
| Place name | Point | 6500 | TX |
| Station name | Point | 6551 | TX |

Record Breakdown

NTF Record List

This list comprises the valid record types used in the Meridian NTF Transfer Set.

| Desc | Description | Record Name |
|------|---|-------------|
| 01 | Volume Header Record - defines the donor and data type | [VOLHDREC] |
| 02 | Database Header Record - transfers data about the database | [DBHREC] |
| 05 | Feature Classification Record - defines data classifications | [FEATCLASS] |
| 07 | Section Header Record - coordinate and structure types, unit scale, factors, etc. | [SECHREC] |
| 14 | Attribute Record - defines the attributes for line and point records | [ATTREC] |
| 15 | Point Record - identifies the definition of node points | [POINTREC] |
| 16 | Node Record - defines the topological relationship between links and nodes | [NODEREC] |
| 21 | Two-dimensional Geometry Record - defines the two-dimensional geometry for a link or node | [GEOMETRY1] |
| 23 | Line Record - identifies the definition of a link | [LINEREC] |
| 40 | Attribute Description Record - defines attribute descriptions and their fields | [ATTDESC] |
| 43 | Text Record - identifies the Text Position Record and Attribute Record | [TEXTREC] |
| 44 | Text Position Record - identifies the Text Representation Record and Geometry Record | [TEXTPOS] |
| 45 | Text Representation Record - defines the font, text height and digitised position | [TEXTREP] |
| 99 | Volume Terminator Record - defines the end of the transfer set | [VOLTERM] |

Note: Desc = descriptor

Volume Header Record [VOLHDREC] 01

| Field | Position | Format | Description | |
|-----------|----------|--------|-----------------|--|
| REC_DESC | 01:02 | A2 | 01 | |
| DONOR | 03:22 | A20 | ORDNANCE SURVEY | |
| RECIPIENT | 23:42 | A20 | <20S> | Not used |
| TRANDATE | 43:50 | DATE | yyyymmdd | Supply date |
| SERIAL | 51:54 | I4 | 0000 | Not used |
| VOLNUM | 55:56 | I2 | nn | Volume number 01 to 99 |
| NTFLEVEL | 57:57 | I1 | 3 | |
| NTFVER | 58:61 | R4.2 | 0200 | i.e. Version 2.0 |
| NTFOR | 62:62 | A1 | V | Variable length records |
| EOR | 63:63 | A1 | % | i.e % on magnetic type, or <S> |
| DIVIDER | 64:64 | A1 | \ | Divider used to terminate variable length text fields |
| CONT_MARK | 65:65 | I1 | 0 | No further records |
| EOR | 66:66 | A1 | % | i.e. ASCII 37 |

Record Example

01ORDNANCE SURVEY 1995113000000130200V \%

| 1 | | 2 | | 3 | | 4 | | 5 | | 6 | | 7 | | 8 | |
|---|---|---|---|---|---|---|---|---|---|---|---|---|---|---|---|
| 1 | 2 | 3 | 4 | 5 | 6 | 7 | 8 | 9 | 0 | 1 | 2 | 3 | 4 | 5 | 6 |
| 1 | 2 | 3 | 4 | 5 | 6 | 7 | 8 | 9 | 0 | 1 | 2 | 3 | 4 | 5 | 6 |
| 1 | 2 | 3 | 4 | 5 | 6 | 7 | 8 | 9 | 0 | 1 | 2 | 3 | 4 | 5 | 6 |

Template

Database Header Record [DBHREC] 02

Record 1

| Field | Position | Format | Description |
|-----------|----------|--------|---|
| REC_DESC | 01:02 | A2 | 02 |
| DBNAME | 03:22 | A20 | Meridian_01.95<6S> Database name |
| DDNAME | 23:42 | A20 | DEFAULT_02.00<7S> |
| DDATE | 43:50 | DATE | 19920515 Release date of NTF version being used |
| DDBASE | 51:70 | A20 | <20S> Not used |
| DDBDATE | 71:78 | DATE | 00000000 Not used |
| CONT_MARK | 79:79 | I1 | 1 Followed by continuation record |
| EOR | 80:80 | A1 | % i.e. ASCII 37 |

Record 2

| Field | Position | Format | Description |
|------------|----------|--------|---|
| REC_DESC | 01:02 | A2 | 00 |
| FCNAME | 03:22 | A20 | Meridian_01.00<6S> Data Specification (Product Version) |
| FCDATE | 23:30 | DATE | 19950901 Date of Data Specification |
| DQNAME | 31:50 | A20 | <20S> Not used |
| DQDATE | 51:58 | DATE | 00000000 Not used |
| DATA_MODEL | 59:60 | I2 | 00 |
| CONT_MARK | 61:61 | I1 | 0 No further records |
| EOR | 62:62 | A1 | % i.e. ASCII 37 |

Record Example

```

02Meridian_01.95      DEFAULT_02.00      19920515      000000001%
00Meridian_01.00      19950901      000000000000%
    
```

| 1 | | 2 | | 3 | | 4 | | 5 | | 6 | | 7 | | 8 | | | | | |
|---|---|---|---|---|---|---|---|---|---|---|---|---|---|---|---|---|---|---|---|
| 1 | 2 | 3 | 4 | 5 | 6 | 7 | 8 | 9 | 0 | 1 | 2 | 3 | 4 | 5 | 6 | 7 | 8 | 9 | 0 |

Template

Feature Classification Record [FEATCLASS] 05

| Field | Position | Format | Description |
|-----------|----------|--------|-----------------------------------|
| REC_DESC | 01:02 | A2 | 05 |
| FEAT_CODE | 03:06 | I4 | Contains 4-character feature code |
| CODE_COM | 07:16 | A10 | <10S> Not used |
| STCLASS | 17:36 | A20 | <20S> Not used |
| FEATDES | 37:* | A* | Feature description |
| DIVIDER | *:* | A1 | \ |
| CONT_MARK | *:* | I1 | 0 No further records |
| EOR | *:* | A1 | % i.e. ASCII 37 |

* = variable

Record Example

056001

Motorway\0%

| | | | | | | | | |
|---|---|---|---|---|---|---|---|---|
| | 1 | 2 | 3 | 4 | 5 | 6 | 7 | 8 |
| 1 | 2 | 3 | 4 | 5 | 6 | 7 | 8 | 9 |
| 1 | 2 | 3 | 4 | 5 | 6 | 7 | 8 | 9 |
| 1 | 2 | 3 | 4 | 5 | 6 | 7 | 8 | 9 |
| 1 | 2 | 3 | 4 | 5 | 6 | 7 | 8 | 9 |
| 1 | 2 | 3 | 4 | 5 | 6 | 7 | 8 | 9 |
| 1 | 2 | 3 | 4 | 5 | 6 | 7 | 8 | 9 |
| 1 | 2 | 3 | 4 | 5 | 6 | 7 | 8 | 9 |
| 1 | 2 | 3 | 4 | 5 | 6 | 7 | 8 | 9 |

Template

Section Header Record [SECHREC] 07

Record 1

| <u>Field</u> | <u>Position</u> | <u>Format</u> | <u>Description</u> |
|--------------|-----------------|---------------|--|
| REC_DESC | 01:02 | A2 | 07 |
| SECT_REF | 03:12 | A10 | 20 km by 20 km tile reference e.g.TQ24<6S> |
| COORD_TYP | 13:13 | I1 | Rectangular |
| STRUCT_TYP | 14:14 | I1 | Vector |
| XYLEN | 15:19 | I5 | 5-character coord fields (to 1 metre) |
| XY_UNIT | 20:20 | I1 | Metres |
| XY_MULT | 21:30 | R10.3 | Default |
| ZLEN | 31:35 | I5 | Not used |
| Z_UNIT | 36:36 | I1 | Not used |
| Z_MULT | 37:46 | R10.3 | Not used |
| X_ORIG | 47:56 | I10 | X-coord of SW corner of unit |
| Y_ORIG | 57:66 | I10 | Y-coord of SW corner of unit |
| Z_DATUM | 67:76 | I10 | Not used |
| CONT_MARK | 77:77 | I1 | Followed by continuation record |
| EOR | 78:78 | A1 | i.e. ASCII 37 |

Record 2

| Field | Position | Format | Description |
|-----------|----------|--------|----------------------------|
| REC_DESC | 01:02 | A2 | 00 |
| XMIN | 03:12 | I10 | 0000000000 |
| YMIN | 13:22 | I10 | 0000000000 |
| XMAX | 23:32 | I10 | 0000020000 |
| YMAX | 33:42 | I10 | 0000020000 |
| XY_ACC | 43:47 | R5.2 | 00000 Not used |
| Z_ACC | 48:52 | R5.2 | 00000 Not used |
| SURV_DATE | 53:60 | DATE | 00000000 Not used |
| LAST_AMND | 61:68 | DATE | yyyymmdd Date last amended |
| COPYRIGHT | 69:76 | DATE | yyyymmdd Copyright date |
| CONT_MARK | 77:77 | I1 | 0 No further records |
| EOR | 78:78 | A1 | % i.e. ASCII 37 |

Record Example

```
07TQ24          21000052000000100000000000000010000000520000000014000000000000001%
00000000000000000000000000000002000000000200000000000000000000000019950901199509010%
```

| | 1 | 2 | 3 | 4 | 5 | 6 | 7 | 8 |
|---|---|---|---|---|---|---|---|---|
| 1 | 2 | 3 | 4 | 5 | 6 | 7 | 8 | 9 |
| 1 | 2 | 3 | 4 | 5 | 6 | 7 | 8 | 9 |
| 1 | 2 | 3 | 4 | 5 | 6 | 7 | 8 | 9 |
| 1 | 2 | 3 | 4 | 5 | 6 | 7 | 8 | 9 |
| 1 | 2 | 3 | 4 | 5 | 6 | 7 | 8 | 9 |
| 1 | 2 | 3 | 4 | 5 | 6 | 7 | 8 | 9 |
| 1 | 2 | 3 | 4 | 5 | 6 | 7 | 8 | 9 |
| 1 | 2 | 3 | 4 | 5 | 6 | 7 | 8 | 9 |
| 1 | 2 | 3 | 4 | 5 | 6 | 7 | 8 | 9 |
| 1 | 2 | 3 | 4 | 5 | 6 | 7 | 8 | 9 |
| 1 | 2 | 3 | 4 | 5 | 6 | 7 | 8 | 9 |

Template

Attribute Record [ATTREC] 14

Road Links

| <u>Field</u> | <u>Position</u> | <u>Format</u> | <u>Description</u> |
|--------------|-----------------|---------------|---|
| REC_DESC | 01:02 | A2 | 14 |
| ATT_ID | 03:08 | I6 | Unique attribute record identifier |
| VAL_TYPE | 09:10 | A2 | OM |
| VALUE | 11:23 | A13 | Unique Identifier - OSMDR |
| VAL_TYPE | 24:25 | A2 | FC |
| VALUE | 26:29 | I4 | Feature Code |
| VAL_TYPE | 30:31 | A2 | RN |
| VALUE | 32:* | A* | DoT Road Number (optional) |
| DIVIDER | *.* | A1 | \ |
| VAL_TYPE | *.* | A2 | TR |
| VALUE | *.* | A1 | Trunk Road indicator (optional) |
| CONT_MARK | *.* | I1 | 0 or 1 |
| EOR | *.* | A1 | 1 if followed by continuation record i.e. ASCII 37 |

* = variable

Record Example

14000001OMOM38UHK0PLWAXFC6041RNA343\TRY0%

| | 1 | 2 | 3 | 4 | 5 | 6 | 7 | 8 |
|--|------------|------------|------------|------------|------------|------------|------------|------------|
| | 1 | 2 | 3 | 4 | 5 | 6 | 7 | 8 |
| | 1234567890 | 1234567890 | 1234567890 | 1234567890 | 1234567890 | 1234567890 | 1234567890 | 1234567890 |

Template

Road Nodes

| Field | Position | Format | Description |
|-----------|----------|--------|---|
| REC_DESC | 01:02 | A2 | 14 |
| ATT_ID | 03:08 | I6 | Unique attribute record identifier |
| VAL_TYPE | 09:10 | A2 | OM |
| VALUE | 11:23 | A13 | Unique Identifier - OSMDR |
| VAL_TYPE | 24:25 | A2 | FC |
| VALUE | 26:29 | I4 | Feature Code |
| VAL_TYPE | 30:31 | A2 | JN |
| VALUE | 32:* | A* | Junction name (optional - m'way juncs only) |
| DIVIDER | *.* | A1 | \ |
| VAL_TYPE | *.* | A2 | RT |
| VALUE | *.* | A1 | Roundabout indicator (optional) 1 if followed by continuation record |
| CONT_MARK | *.* | I1 | 0 or 1 |
| EOR | *.* | A1 | % i.e. ASCII 37 |

* = variable

Record Example

14000002OMOMDF42CK0VTEGFC6700JNM27 J2\RTY0%

| | | | | | | | | |
|---|---|---|---|---|---|---|---|---|
| | 1 | 2 | 3 | 4 | 5 | 6 | 7 | 8 |
| 1 | 2 | 3 | 4 | 5 | 6 | 7 | 8 | 9 |
| 0 | 1 | 2 | 3 | 4 | 5 | 6 | 7 | 8 |
| 1 | 2 | 3 | 4 | 5 | 6 | 7 | 8 | 9 |
| 2 | 3 | 4 | 5 | 6 | 7 | 8 | 9 | 0 |
| 3 | 4 | 5 | 6 | 7 | 8 | 9 | 0 | 1 |
| 4 | 5 | 6 | 7 | 8 | 9 | 0 | 1 | 2 |
| 5 | 6 | 7 | 8 | 9 | 0 | 1 | 2 | 3 |
| 6 | 7 | 8 | 9 | 0 | 1 | 2 | 3 | 4 |
| 7 | 8 | 9 | 0 | 1 | 2 | 3 | 4 | 5 |
| 8 | 9 | 0 | 1 | 2 | 3 | 4 | 5 | 6 |
| 9 | 0 | 1 | 2 | 3 | 4 | 5 | 6 | 7 |
| 0 | 1 | 2 | 3 | 4 | 5 | 6 | 7 | 8 |
| 1 | 2 | 3 | 4 | 5 | 6 | 7 | 8 | 9 |
| 2 | 3 | 4 | 5 | 6 | 7 | 8 | 9 | 0 |
| 3 | 4 | 5 | 6 | 7 | 8 | 9 | 0 | 1 |
| 4 | 5 | 6 | 7 | 8 | 9 | 0 | 1 | 2 |
| 5 | 6 | 7 | 8 | 9 | 0 | 1 | 2 | 3 |
| 6 | 7 | 8 | 9 | 0 | 1 | 2 | 3 | 4 |
| 7 | 8 | 9 | 0 | 1 | 2 | 3 | 4 | 5 |
| 8 | 9 | 0 | 1 | 2 | 3 | 4 | 5 | 6 |
| 9 | 0 | 1 | 2 | 3 | 4 | 5 | 6 | 7 |

Template

Administrative Area Links (County, District, Coastline and neat line)

| <u>Field</u> | <u>Position</u> | <u>Format</u> | <u>Description</u> |
|--------------|-----------------|---------------|---|
| REC_DESC | 01:02 | A2 | 14 |
| ATT_ID | 03:08 | I6 | Unique attribute record identifier |
| VAL_TYPE | 09:10 | A2 | FC |
| VALUE | 11:14 | I4 | Feature Code |
| AL_TYPE | 15:16 | A2 | LC |
| VALUE | 17:22 | I6 | Left County pointer to seed (optional) |
| AL_TYPE | 23:24 | A2 | RC |
| VALUE | 25:30 | I6 | Right County pointer to seed (optional) |
| VAL_TYPE | 31:32 | A2 | LD |
| VALUE | 33:38 | I6 | Left District pointer to seed (optional) |
| AL_TYPE | 39:40 | A2 | RD |
| VALUE | 41:46 | I6 | Right District pointer to seed (optional) |
| CONT_MARK | 47:47 | I1 | 0 |
| EOR | 48:48 | A1 | % i.e. ASCII 37 |

Record Example

14000014FC6405LC043050RC043084LD069234RD0697200%

| | | | | | | | | |
|---|---|---|---|---|---|---|---|---|
| | 1 | 2 | 3 | 4 | 5 | 6 | 7 | 8 |
| 1 | 2 | 3 | 4 | 5 | 6 | 7 | 8 | 9 |
| 0 | 1 | 2 | 3 | 4 | 5 | 6 | 7 | 8 |
| 9 | 0 | 1 | 2 | 3 | 4 | 5 | 6 | 7 |
| 8 | 9 | 0 | 1 | 2 | 3 | 4 | 5 | 6 |
| 7 | 8 | 9 | 0 | 1 | 2 | 3 | 4 | 5 |
| 6 | 7 | 8 | 9 | 0 | 1 | 2 | 3 | 4 |
| 5 | 6 | 7 | 8 | 9 | 0 | 1 | 2 | 3 |
| 4 | 5 | 6 | 7 | 8 | 9 | 0 | 1 | 2 |
| 3 | 4 | 5 | 6 | 7 | 8 | 9 | 0 | 1 |
| 2 | 3 | 4 | 5 | 6 | 7 | 8 | 9 | 0 |
| 1 | 2 | 3 | 4 | 5 | 6 | 7 | 8 | 9 |
| 0 | 1 | 2 | 3 | 4 | 5 | 6 | 7 | 8 |

Template

Administrative Area Points/Seeds

| Field | Position | Format | Description |
|-----------|----------|--------|--|
| REC_DESC | 01:02 | A2 | 14 |
| ATT_ID | 03:08 | I6 | Unique attribute record identifier |
| VAL_TYPE | 09:10 | A2 | FC |
| VALUE | 11:14 | I4 | Feature Code |
| VAL_TYPE | 15:16 | A2 | PI |
| VALUE | 17:22 | I6 | Unique Global (Seed) Identifier |
| VAL_TYPE | 23:24 | A2 | NM |
| VALUE | 25:* | A* | Admin Area Name |
| DIVIDER | *.* | A1 | \ |
| CONT_MARK | *.* | I1 | 0 or 1 |
| EOR | *.* | A1 | % 1 if followed by a continuation record i.e. ASCII 37 |

* = variable

Record Example

14000032FC6411PI043050NMHAMPSHIRE COUNTY\0%

| | | | | | | | | |
|---|---|---|---|---|---|---|---|---|
| | 1 | 2 | 3 | 4 | 5 | 6 | 7 | 8 |
| 1 | 2 | 3 | 4 | 5 | 6 | 7 | 8 | 9 |
| 0 | 1 | 2 | 3 | 4 | 5 | 6 | 7 | 8 |
| 1 | 2 | 3 | 4 | 5 | 6 | 7 | 8 | 9 |
| 2 | 3 | 4 | 5 | 6 | 7 | 8 | 9 | 0 |
| 3 | 4 | 5 | 6 | 7 | 8 | 9 | 0 | 1 |
| 4 | 5 | 6 | 7 | 8 | 9 | 0 | 1 | 2 |
| 5 | 6 | 7 | 8 | 9 | 0 | 1 | 2 | 3 |
| 6 | 7 | 8 | 9 | 0 | 1 | 2 | 3 | 4 |
| 7 | 8 | 9 | 0 | 1 | 2 | 3 | 4 | 5 |
| 8 | 9 | 0 | 1 | 2 | 3 | 4 | 5 | 6 |
| 9 | 0 | 1 | 2 | 3 | 4 | 5 | 6 | 7 |
| 0 | 1 | 2 | 3 | 4 | 5 | 6 | 7 | 8 |
| 1 | 2 | 3 | 4 | 5 | 6 | 7 | 8 | 9 |
| 2 | 3 | 4 | 5 | 6 | 7 | 8 | 9 | 0 |
| 3 | 4 | 5 | 6 | 7 | 8 | 9 | 0 | 1 |
| 4 | 5 | 6 | 7 | 8 | 9 | 0 | 1 | 2 |
| 5 | 6 | 7 | 8 | 9 | 0 | 1 | 2 | 3 |
| 6 | 7 | 8 | 9 | 0 | 1 | 2 | 3 | 4 |
| 7 | 8 | 9 | 0 | 1 | 2 | 3 | 4 | 5 |
| 8 | 9 | 0 | 1 | 2 | 3 | 4 | 5 | 6 |
| 9 | 0 | 1 | 2 | 3 | 4 | 5 | 6 | 7 |
| 0 | 1 | 2 | 3 | 4 | 5 | 6 | 7 | 8 |
| 1 | 2 | 3 | 4 | 5 | 6 | 7 | 8 | 9 |
| 2 | 3 | 4 | 5 | 6 | 7 | 8 | 9 | 0 |
| 3 | 4 | 5 | 6 | 7 | 8 | 9 | 0 | 1 |
| 4 | 5 | 6 | 7 | 8 | 9 | 0 | 1 | 2 |
| 5 | 6 | 7 | 8 | 9 | 0 | 1 | 2 | 3 |
| 6 | 7 | 8 | 9 | 0 | 1 | 2 | 3 | 4 |
| 7 | 8 | 9 | 0 | 1 | 2 | 3 | 4 | 5 |
| 8 | 9 | 0 | 1 | 2 | 3 | 4 | 5 | 6 |
| 9 | 0 | 1 | 2 | 3 | 4 | 5 | 6 | 7 |
| 0 | 1 | 2 | 3 | 4 | 5 | 6 | 7 | 8 |
| 1 | 2 | 3 | 4 | 5 | 6 | 7 | 8 | 9 |
| 2 | 3 | 4 | 5 | 6 | 7 | 8 | 9 | 0 |
| 3 | 4 | 5 | 6 | 7 | 8 | 9 | 0 | 1 |
| 4 | 5 | 6 | 7 | 8 | 9 | 0 | 1 | 2 |
| 5 | 6 | 7 | 8 | 9 | 0 | 1 | 2 | 3 |
| 6 | 7 | 8 | 9 | 0 | 1 | 2 | 3 | 4 |
| 7 | 8 | 9 | 0 | 1 | 2 | 3 | 4 | 5 |
| 8 | 9 | 0 | 1 | 2 | 3 | 4 | 5 | 6 |
| 9 | 0 | 1 | 2 | 3 | 4 | 5 | 6 | 7 |
| 0 | 1 | 2 | 3 | 4 | 5 | 6 | 7 | 8 |
| 1 | 2 | 3 | 4 | 5 | 6 | 7 | 8 | 9 |
| 2 | 3 | 4 | 5 | 6 | 7 | 8 | 9 | 0 |
| 3 | 4 | 5 | 6 | 7 | 8 | 9 | 0 | 1 |
| 4 | 5 | 6 | 7 | 8 | 9 | 0 | 1 | 2 |
| 5 | 6 | 7 | 8 | 9 | 0 | 1 | 2 | 3 |
| 6 | 7 | 8 | 9 | 0 | 1 | 2 | 3 | 4 |
| 7 | 8 | 9 | 0 | 1 | 2 | 3 | 4 | 5 |
| 8 | 9 | 0 | 1 | 2 | 3 | 4 | 5 | 6 |
| 9 | 0 | 1 | 2 | 3 | 4 | 5 | 6 | 7 |
| 0 | 1 | 2 | 3 | 4 | 5 | 6 | 7 | 8 |
| 1 | 2 | 3 | 4 | 5 | 6 | 7 | 8 | 9 |
| 2 | 3 | 4 | 5 | 6 | 7 | 8 | 9 | 0 |
| 3 | 4 | 5 | 6 | 7 | 8 | 9 | 0 | 1 |
| 4 | 5 | 6 | 7 | 8 | 9 | 0 | 1 | 2 |
| 5 | 6 | 7 | 8 | 9 | 0 | 1 | 2 | 3 |
| 6 | 7 | 8 | 9 | 0 | 1 | 2 | 3 | 4 |
| 7 | 8 | 9 | 0 | 1 | 2 | 3 | 4 | 5 |
| 8 | 9 | 0 | 1 | 2 | 3 | 4 | 5 | 6 |
| 9 | 0 | 1 | 2 | 3 | 4 | 5 | 6 | 7 |
| 0 | 1 | 2 | 3 | 4 | 5 | 6 | 7 | 8 |
| 1 | 2 | 3 | 4 | 5 | 6 | 7 | 8 | 9 |
| 2 | 3 | 4 | 5 | 6 | 7 | 8 | 9 | 0 |
| 3 | 4 | 5 | 6 | 7 | 8 | 9 | 0 | 1 |
| 4 | 5 | 6 | 7 | 8 | 9 | 0 | 1 | 2 |
| 5 | 6 | 7 | 8 | 9 | 0 | 1 | 2 | 3 |
| 6 | 7 | 8 | 9 | 0 | 1 | 2 | 3 | 4 |
| 7 | 8 | 9 | 0 | 1 | 2 | 3 | 4 | 5 |
| 8 | 9 | 0 | 1 | 2 | 3 | 4 | 5 | 6 |
| 9 | 0 | 1 | 2 | 3 | 4 | 5 | 6 | 7 |
| 0 | 1 | 2 | 3 | 4 | 5 | 6 | 7 | 8 |
| 1 | 2 | 3 | 4 | 5 | 6 | 7 | 8 | 9 |
| 2 | 3 | 4 | 5 | 6 | 7 | 8 | 9 | 0 |
| 3 | 4 | 5 | 6 | 7 | 8 | 9 | 0 | 1 |
| 4 | 5 | 6 | 7 | 8 | 9 | 0 | 1 | 2 |
| 5 | 6 | 7 | 8 | 9 | 0 | 1 | 2 | 3 |
| 6 | 7 | 8 | 9 | 0 | 1 | 2 | 3 | 4 |
| 7 | 8 | 9 | 0 | 1 | 2 | 3 | 4 | 5 |
| 8 | 9 | 0 | 1 | 2 | 3 | 4 | 5 | 6 |
| 9 | 0 | 1 | 2 | 3 | 4 | 5 | 6 | 7 |
| 0 | 1 | 2 | 3 | 4 | 5 | 6 | 7 | 8 |
| 1 | 2 | 3 | 4 | 5 | 6 | 7 | 8 | 9 |
| 2 | 3 | 4 | 5 | 6 | 7 | 8 | 9 | 0 |
| 3 | 4 | 5 | 6 | 7 | 8 | 9 | 0 | 1 |
| 4 | 5 | 6 | 7 | 8 | 9 | 0 | 1 | 2 |
| 5 | 6 | 7 | 8 | 9 | 0 | 1 | 2 | 3 |
| 6 | 7 | 8 | 9 | 0 | 1 | 2 | 3 | 4 |
| 7 | 8 | 9 | 0 | 1 | 2 | 3 | 4 | 5 |
| 8 | 9 | 0 | 1 | 2 | 3 | 4 | 5 | 6 |
| 9 | 0 | 1 | 2 | 3 | 4 | 5 | 6 | 7 |
| 0 | 1 | 2 | 3 | 4 | 5 | 6 | 7 | 8 |
| 1 | 2 | 3 | 4 | 5 | 6 | 7 | 8 | 9 |
| 2 | 3 | 4 | 5 | 6 | 7 | 8 | 9 | 0 |
| 3 | 4 | 5 | 6 | 7 | 8 | 9 | 0 | 1 |
| 4 | 5 | 6 | 7 | 8 | 9 | 0 | 1 | 2 |
| 5 | 6 | 7 | 8 | 9 | 0 | 1 | 2 | 3 |
| 6 | 7 | 8 | 9 | 0 | 1 | 2 | 3 | 4 |
| 7 | 8 | 9 | 0 | 1 | 2 | 3 | 4 | 5 |
| 8 | 9 | 0 | 1 | 2 | 3 | 4 | 5 | 6 |
| 9 | 0 | 1 | 2 | 3 | 4 | 5 | 6 | 7 |
| 0 | 1 | 2 | 3 | 4 | 5 | 6 | 7 | 8 |
| 1 | 2 | 3 | 4 | 5 | 6 | 7 | 8 | 9 |
| 2 | 3 | 4 | 5 | 6 | 7 | 8 | 9 | 0 |
| 3 | 4 | 5 | 6 | 7 | 8 | 9 | 0 | 1 |
| 4 | 5 | 6 | 7 | 8 | 9 | 0 | 1 | 2 |
| 5 | 6 | 7 | 8 | 9 | 0 | 1 | 2 | 3 |
| 6 | 7 | 8 | 9 | 0 | 1 | 2 | 3 | 4 |
| 7 | 8 | 9 | 0 | 1 | 2 | 3 | 4 | 5 |
| 8 | 9 | 0 | 1 | 2 | 3 | 4 | 5 | 6 |
| 9 | 0 | 1 | 2 | 3 | 4 | 5 | 6 | 7 |
| 0 | 1 | 2 | 3 | 4 | 5 | 6 | 7 | 8 |
| 1 | 2 | 3 | 4 | 5 | 6 | 7 | 8 | 9 |
| 2 | 3 | 4 | 5 | 6 | 7 | 8 | 9 | 0 |
| 3 | 4 | 5 | 6 | 7 | 8 | 9 | 0 | 1 |
| 4 | 5 | 6 | 7 | 8 | 9 | 0 | 1 | 2 |
| 5 | 6 | 7 | 8 | 9 | 0 | 1 | 2 | 3 |
| 6 | 7 | 8 | 9 | 0 | 1 | 2 | 3 | 4 |
| 7 | 8 | 9 | 0 | 1 | 2 | 3 | 4 | 5 |
| 8 | 9 | 0 | 1 | 2 | 3 | 4 | 5 | 6 |
| 9 | 0 | 1 | 2 | 3 | 4 | 5 | 6 | 7 |
| 0 | 1 | 2 | 3 | 4 | 5 | 6 | 7 | 8 |
| 1 | 2 | 3 | 4 | 5 | 6 | 7 | 8 | 9 |
| 2 | 3 | 4 | 5 | 6 | 7 | 8 | 9 | 0 |
| 3 | 4 | 5 | 6 | 7 | 8 | 9 | 0 | 1 |
| 4 | 5 | 6 | 7 | 8 | 9 | 0 | 1 | 2 |
| 5 | 6 | 7 | 8 | 9 | 0 | 1 | 2 | 3 |
| 6 | 7 | 8 | 9 | 0 | 1 | 2 | 3 | 4 |
| 7 | 8 | 9 | 0 | 1 | 2 | 3 | 4 | 5 |
| 8 | 9 | 0 | 1 | 2 | 3 | 4 | 5 | 6 |
| 9 | 0 | 1 | 2 | 3 | 4 | 5 | 6 | 7 |
| 0 | 1 | 2 | 3 | 4 | 5 | 6 | 7 | 8 |
| 1 | 2 | 3 | 4 | 5 | 6 | 7 | 8 | 9 |
| 2 | 3 | 4 | 5 | 6 | 7 | 8 | 9 | 0 |
| 3 | 4 | 5 | 6 | 7 | 8 | 9 | 0 | 1 |
| 4 | 5 | 6 | 7 | 8 | 9 | 0 | 1 | 2 |
| 5 | 6 | 7 | 8 | 9 | 0 | 1 | 2 | 3 |
| 6 | 7 | 8 | 9 | 0 | 1 | 2 | 3 | 4 |
| 7 | 8 | 9 | 0 | 1 | 2 | 3 | 4 | 5 |
| 8 | 9 | 0 | 1 | 2 | 3 | 4 | 5 | 6 |
| 9 | 0 | 1 | 2 | 3 | 4 | 5 | 6 | 7 |
| 0 | 1 | 2 | 3 | 4 | 5 | 6 | 7 | 8 |
| 1 | 2 | 3 | 4 | 5 | 6 | 7 | 8 | 9 |
| 2 | 3 | 4 | 5 | 6 | 7 | 8 | 9 | 0 |
| 3 | 4 | 5 | 6 | 7 | 8 | 9 | 0 | 1 |
| 4 | 5 | 6 | 7 | 8 | 9 | 0 | 1 | 2 |
| 5 | 6 | 7 | 8 | 9 | 0 | 1 | 2 | 3 |
| 6 | 7 | 8 | 9 | 0 | 1 | 2 | 3 | 4 |
| 7 | 8 | 9 | 0 | 1 | 2 | 3 | 4 | 5 |
| 8 | 9 | 0 | 1 | 2 | 3 | 4 | 5 | 6 |
| 9 | 0 | 1 | 2 | 3 | 4 | 5 | 6 | 7 |
| 0 | 1 | 2 | 3 | 4 | 5 | 6 | 7 | 8 |
| 1 | 2 | 3 | 4 | 5 | 6 | 7 | 8 | 9 |
| 2 | 3 | 4 | 5 | 6 | 7 | 8 | 9 | 0 |
| 3 | 4 | 5 | 6 | 7 | 8 | 9 | 0 | 1 |
| 4 | 5 | 6 | 7 | 8 | 9 | 0 | 1 | 2 |
| 5 | 6 | 7 | 8 | 9 | 0 | 1 | 2 | 3 |
| 6 | 7 | 8 | 9 | 0 | 1 | 2 | 3 | 4 |
| 7 | 8 | 9 | 0 | 1 | 2 | 3 | 4 | 5 |
| 8 | 9 | 0 | 1 | 2 | 3 | 4 | 5 | 6 |
| 9 | 0 | 1 | 2 | 3 | 4 | 5 | 6 | 7 |
| 0 | 1 | 2 | 3 | 4 | 5 | 6 | 7 | 8 |
| 1 | 2 | 3 | 4 | 5 | 6 | 7 | 8 | 9 |
| 2 | 3 | 4 | 5 | 6 | 7 | 8 | 9 | 0 |
| 3 | 4 | 5 | 6 | 7 | 8 | 9 | 0 | 1 |
| 4 | 5 | 6 | 7 | 8 | 9 | 0 | 1 | 2 |
| 5 | 6 | 7 | 8 | 9 | 0 | 1 | 2 | 3 |
| 6 | 7 | 8 | 9 | 0 | 1 | 2 | 3 | 4 |
| 7 | 8 | 9 | 0 | 1 | 2 | 3 | 4 | 5 |
| 8 | 9 | 0 | 1 | 2 | 3 | 4 | 5 | 6 |
| 9 | 0 | 1 | 2 | 3 | 4 | 5 | 6 | 7 |
| 0 | 1 | 2 | 3 | 4 | 5 | 6 | 7 | 8 |
| 1 | 2 | 3 | 4 | 5 | 6 | 7 | 8 | 9 |
| 2 | 3 | 4 | 5 | 6 | 7 | 8 | 9 | 0 |
| 3 | 4 | 5 | 6 | 7 | 8 | 9 | 0 | 1 |
| 4 | 5 | 6 | 7 | 8 | 9 | 0 | 1 | 2 |
| 5 | 6 | 7 | 8 | 9 | 0 | 1 | 2 | 3 |
| 6 | 7 | 8 | 9 | 0 | 1 | 2 | 3 | 4 |
| 7 | 8 | 9 | 0 | 1 | 2 | 3 | 4 | 5 |
| 8 | 9 | 0 | 1 | 2 | 3 | 4 | 5 | 6 |
| 9 | 0 | 1 | 2 | 3 | 4 | 5 | 6 | 7 |
| 0 | 1 | 2 | 3 | 4 | 5 | 6 | 7 | 8 |
| 1 | 2 | 3 | 4 | 5 | 6 | 7 | 8 | 9 |
| 2 | 3 | 4 | 5 | 6 | 7 | 8 | 9 | 0 |

Nodes (Administrative Areas, Developed Land Use Area, Coastline and Railway), Edge nodes (all layers)

| <u>Field</u> | <u>Position</u> | <u>Format</u> | <u>Description</u> |
|--------------|-----------------|---------------|------------------------------------|
| REC_DESC | 01:02 | A2 | 14 |
| ATT_ID | 03:08 | I6 | Unique attribute record identifier |
| VAL_TYPE | 09:10 | A2 | FC |
| VALUE | 11:14 | I4 | Feature Code |
| CONT_MARK | 15:15 | I1 | No further records |
| EOR | 16:16 | A1 | i.e. ASCII 37 |

Developed Land Use Area Links

| <u>Field</u> | <u>Position</u> | <u>Format</u> | <u>Description</u> |
|--------------|-----------------|---------------|------------------------------------|
| REC_DESC | 01:02 | A2 | 14 |
| ATT_ID | 03:08 | I6 | Unique attribute record identifier |
| VAL_TYPE | 09:10 | A2 | FC |
| VALUE | 11:14 | I4 | Feature Code |
| CONT_MARK | 15:15 | I1 | No further records |
| EOR | 16:16 | A1 | i.e. ASCII 37 |

Developed Land Use Area Points/Seeds

| Field | Position | Format | Description |
|-----------|----------|--------|--|
| REC_DESC | 01:02 | A2 | 14 |
| ATT_ID | 03:08 | I6 | Unique attribute record identifier |
| VAL_TYPE | 09:10 | A2 | FC |
| VALUE | 11:14 | I4 | Feature Code |
| VAL_TYPE | 15:16 | A2 | DA |
| VALUE | 17:29 | A13 | Unique Developed Land Use Area (Seed) Identifier |
| VAL_TYPE | 30:31 | A2 | PN |
| VALUE | 32:* | A* | Developed Land Use Area Name |
| DIVIDER | *.* | A1 | \ |
| CONT_MARK | *.* | I1 | 0 or 1 |
| EOR | *.* | A1 | % |

* = variable

Record Example

14000032FC6310DA4418200463301PNGrafton\0%

| | | | | | | | | |
|---|---|---|---|---|---|---|---|---|
| | 1 | 2 | 3 | 4 | 5 | 6 | 7 | 8 |
| 1 | 2 | 3 | 4 | 5 | 6 | 7 | 8 | 9 |
| 0 | 1 | 2 | 3 | 4 | 5 | 6 | 7 | 8 |
| 1 | 2 | 3 | 4 | 5 | 6 | 7 | 8 | 9 |
| 2 | 3 | 4 | 5 | 6 | 7 | 8 | 9 | 0 |
| 3 | 4 | 5 | 6 | 7 | 8 | 9 | 0 | 1 |
| 4 | 5 | 6 | 7 | 8 | 9 | 0 | 1 | 2 |
| 5 | 6 | 7 | 8 | 9 | 0 | 1 | 2 | 3 |
| 6 | 7 | 8 | 9 | 0 | 1 | 2 | 3 | 4 |
| 7 | 8 | 9 | 0 | 1 | 2 | 3 | 4 | 5 |
| 8 | 9 | 0 | 1 | 2 | 3 | 4 | 5 | 6 |
| 9 | 0 | 1 | 2 | 3 | 4 | 5 | 6 | 7 |
| 0 | 1 | 2 | 3 | 4 | 5 | 6 | 7 | 8 |

Template

Railway Station Nodes

| Field | Position | Format | Description |
|-----------|----------|--------|------------------------------------|
| REC_DESC | 01:02 | A2 | 14 |
| ATT_ID | 03:08 | I6 | Unique attribute record identifier |
| VAL_TYPE | 09:10 | A2 | FC |
| VALUE | 11:14 | I4 | Feature Code |
| VAL_TYPE | 15:16 | A2 | SI |
| VALUE | 17:29 | A13 | Unique Railway Station Identifier |
| VAL_TYPE | 30:31 | A2 | PN |
| VALUE | 32:* | A* | Station Name (optional) |
| DIVIDER | ** | A1 | \ |
| CONT_MARK | ** | I1 | 0 or 1 |
| EOR | ** | A1 | % |

* = variable

Record Example

14000003FC6155SI4169010274901PNSandling Station\0%

| | | | | | | | | |
|---|---|---|---|---|---|---|---|---|
| | 1 | 2 | 3 | 4 | 5 | 6 | 7 | 8 |
| 1 | 2 | 3 | 4 | 5 | 6 | 7 | 8 | 9 |
| 0 | 1 | 2 | 3 | 4 | 5 | 6 | 7 | 8 |
| 1 | 2 | 3 | 4 | 5 | 6 | 7 | 8 | 9 |
| 2 | 3 | 4 | 5 | 6 | 7 | 8 | 9 | 0 |
| 3 | 4 | 5 | 6 | 7 | 8 | 9 | 0 | 1 |
| 4 | 5 | 6 | 7 | 8 | 9 | 0 | 1 | 2 |
| 5 | 6 | 7 | 8 | 9 | 0 | 1 | 2 | 3 |
| 6 | 7 | 8 | 9 | 0 | 1 | 2 | 3 | 4 |
| 7 | 8 | 9 | 0 | 1 | 2 | 3 | 4 | 5 |
| 8 | 9 | 0 | 1 | 2 | 3 | 4 | 5 | 6 |
| 9 | 0 | 1 | 2 | 3 | 4 | 5 | 6 | 7 |
| 0 | 1 | 2 | 3 | 4 | 5 | 6 | 7 | 8 |
| 1 | 2 | 3 | 4 | 5 | 6 | 7 | 8 | 9 |
| 2 | 3 | 4 | 5 | 6 | 7 | 8 | 9 | 0 |
| 3 | 4 | 5 | 6 | 7 | 8 | 9 | 0 | 1 |
| 4 | 5 | 6 | 7 | 8 | 9 | 0 | 1 | 2 |
| 5 | 6 | 7 | 8 | 9 | 0 | 1 | 2 | 3 |
| 6 | 7 | 8 | 9 | 0 | 1 | 2 | 3 | 4 |
| 7 | 8 | 9 | 0 | 1 | 2 | 3 | 4 | 5 |
| 8 | 9 | 0 | 1 | 2 | 3 | 4 | 5 | 6 |
| 9 | 0 | 1 | 2 | 3 | 4 | 5 | 6 | 7 |
| 0 | 1 | 2 | 3 | 4 | 5 | 6 | 7 | 8 |
| 1 | 2 | 3 | 4 | 5 | 6 | 7 | 8 | 9 |
| 2 | 3 | 4 | 5 | 6 | 7 | 8 | 9 | 0 |
| 3 | 4 | 5 | 6 | 7 | 8 | 9 | 0 | 1 |
| 4 | 5 | 6 | 7 | 8 | 9 | 0 | 1 | 2 |
| 5 | 6 | 7 | 8 | 9 | 0 | 1 | 2 | 3 |
| 6 | 7 | 8 | 9 | 0 | 1 | 2 | 3 | 4 |
| 7 | 8 | 9 | 0 | 1 | 2 | 3 | 4 | 5 |
| 8 | 9 | 0 | 1 | 2 | 3 | 4 | 5 | 6 |
| 9 | 0 | 1 | 2 | 3 | 4 | 5 | 6 | 7 |
| 0 | 1 | 2 | 3 | 4 | 5 | 6 | 7 | 8 |
| 1 | 2 | 3 | 4 | 5 | 6 | 7 | 8 | 9 |
| 2 | 3 | 4 | 5 | 6 | 7 | 8 | 9 | 0 |
| 3 | 4 | 5 | 6 | 7 | 8 | 9 | 0 | 1 |
| 4 | 5 | 6 | 7 | 8 | 9 | 0 | 1 | 2 |
| 5 | 6 | 7 | 8 | 9 | 0 | 1 | 2 | 3 |
| 6 | 7 | 8 | 9 | 0 | 1 | 2 | 3 | 4 |
| 7 | 8 | 9 | 0 | 1 | 2 | 3 | 4 | 5 |
| 8 | 9 | 0 | 1 | 2 | 3 | 4 | 5 | 6 |
| 9 | 0 | 1 | 2 | 3 | 4 | 5 | 6 | 7 |
| 0 | 1 | 2 | 3 | 4 | 5 | 6 | 7 | 8 |
| 1 | 2 | 3 | 4 | 5 | 6 | 7 | 8 | 9 |
| 2 | 3 | 4 | 5 | 6 | 7 | 8 | 9 | 0 |
| 3 | 4 | 5 | 6 | 7 | 8 | 9 | 0 | 1 |
| 4 | 5 | 6 | 7 | 8 | 9 | 0 | 1 | 2 |
| 5 | 6 | 7 | 8 | 9 | 0 | 1 | 2 | 3 |
| 6 | 7 | 8 | 9 | 0 | 1 | 2 | 3 | 4 |
| 7 | 8 | 9 | 0 | 1 | 2 | 3 | 4 | 5 |
| 8 | 9 | 0 | 1 | 2 | 3 | 4 | 5 | 6 |
| 9 | 0 | 1 | 2 | 3 | 4 | 5 | 6 | 7 |
| 0 | 1 | 2 | 3 | 4 | 5 | 6 | 7 | 8 |
| 1 | 2 | 3 | 4 | 5 | 6 | 7 | 8 | 9 |
| 2 | 3 | 4 | 5 | 6 | 7 | 8 | 9 | 0 |
| 3 | 4 | 5 | 6 | 7 | 8 | 9 | 0 | 1 |
| 4 | 5 | 6 | 7 | 8 | 9 | 0 | 1 | 2 |
| 5 | 6 | 7 | 8 | 9 | 0 | 1 | 2 | 3 |
| 6 | 7 | 8 | 9 | 0 | 1 | 2 | 3 | 4 |
| 7 | 8 | 9 | 0 | 1 | 2 | 3 | 4 | 5 |
| 8 | 9 | 0 | 1 | 2 | 3 | 4 | 5 | 6 |
| 9 | 0 | 1 | 2 | 3 | 4 | 5 | 6 | 7 |
| 0 | 1 | 2 | 3 | 4 | 5 | 6 | 7 | 8 |
| 1 | 2 | 3 | 4 | 5 | 6 | 7 | 8 | 9 |
| 2 | 3 | 4 | 5 | 6 | 7 | 8 | 9 | 0 |
| 3 | 4 | 5 | 6 | 7 | 8 | 9 | 0 | 1 |
| 4 | 5 | 6 | 7 | 8 | 9 | 0 | 1 | 2 |
| 5 | 6 | 7 | 8 | 9 | 0 | 1 | 2 | 3 |
| 6 | 7 | 8 | 9 | 0 | 1 | 2 | 3 | 4 |
| 7 | 8 | 9 | 0 | 1 | 2 | 3 | 4 | 5 |
| 8 | 9 | 0 | 1 | 2 | 3 | 4 | 5 | 6 |
| 9 | 0 | 1 | 2 | 3 | 4 | 5 | 6 | 7 |
| 0 | 1 | 2 | 3 | 4 | 5 | 6 | 7 | 8 |
| 1 | 2 | 3 | 4 | 5 | 6 | 7 | 8 | 9 |
| 2 | 3 | 4 | 5 | 6 | 7 | 8 | 9 | 0 |
| 3 | 4 | 5 | 6 | 7 | 8 | 9 | 0 | 1 |
| 4 | 5 | 6 | 7 | 8 | 9 | 0 | 1 | 2 |
| 5 | 6 | 7 | 8 | 9 | 0 | 1 | 2 | 3 |
| 6 | 7 | 8 | 9 | 0 | 1 | 2 | 3 | 4 |
| 7 | 8 | 9 | 0 | 1 | 2 | 3 | 4 | 5 |
| 8 | 9 | 0 | 1 | 2 | 3 | 4 | 5 | 6 |
| 9 | 0 | 1 | 2 | 3 | 4 | 5 | 6 | 7 |
| 0 | 1 | 2 | 3 | 4 | 5 | 6 | 7 | 8 |
| 1 | 2 | 3 | 4 | 5 | 6 | 7 | 8 | 9 |
| 2 | 3 | 4 | 5 | 6 | 7 | 8 | 9 | 0 |
| 3 | 4 | 5 | 6 | 7 | 8 | 9 | 0 | 1 |
| 4 | 5 | 6 | 7 | 8 | 9 | 0 | 1 | 2 |
| 5 | 6 | 7 | 8 | 9 | 0 | 1 | 2 | 3 |
| 6 | 7 | 8 | 9 | 0 | 1 | 2 | 3 | 4 |
| 7 | 8 | 9 | 0 | 1 | 2 | 3 | 4 | 5 |
| 8 | 9 | 0 | 1 | 2 | 3 | 4 | 5 | 6 |
| 9 | 0 | 1 | 2 | 3 | 4 | 5 | 6 | 7 |
| 0 | 1 | 2 | 3 | 4 | 5 | 6 | 7 | 8 |
| 1 | 2 | 3 | 4 | 5 | 6 | 7 | 8 | 9 |
| 2 | 3 | 4 | 5 | 6 | 7 | 8 | 9 | 0 |
| 3 | 4 | 5 | 6 | 7 | 8 | 9 | 0 | 1 |
| 4 | 5 | 6 | 7 | 8 | 9 | 0 | 1 | 2 |
| 5 | 6 | 7 | 8 | 9 | 0 | 1 | 2 | 3 |
| 6 | 7 | 8 | 9 | 0 | 1 | 2 | 3 | 4 |
| 7 | 8 | 9 | 0 | 1 | 2 | 3 | 4 | 5 |
| 8 | 9 | 0 | 1 | 2 | 3 | 4 | 5 | 6 |
| 9 | 0 | 1 | 2 | 3 | 4 | 5 | 6 | 7 |
| 0 | 1 | 2 | 3 | 4 | 5 | 6 | 7 | 8 |
| 1 | 2 | 3 | 4 | 5 | 6 | 7 | 8 | 9 |
| 2 | 3 | 4 | 5 | 6 | 7 | 8 | 9 | 0 |
| 3 | 4 | 5 | 6 | 7 | 8 | 9 | 0 | 1 |
| 4 | 5 | 6 | 7 | 8 | 9 | 0 | 1 | 2 |
| 5 | 6 | 7 | 8 | 9 | 0 | 1 | 2 | 3 |
| 6 | 7 | 8 | 9 | 0 | 1 | 2 | 3 | 4 |
| 7 | 8 | 9 | 0 | 1 | 2 | 3 | 4 | 5 |
| 8 | 9 | 0 | 1 | 2 | 3 | 4 | 5 | 6 |
| 9 | 0 | 1 | 2 | 3 | 4 | 5 | 6 | 7 |
| 0 | 1 | 2 | 3 | 4 | 5 | 6 | 7 | 8 |
| 1 | 2 | 3 | 4 | 5 | 6 | 7 | 8 | 9 |
| 2 | 3 | 4 | 5 | 6 | 7 | 8 | 9 | 0 |
| 3 | 4 | 5 | 6 | 7 | 8 | 9 | 0 | 1 |
| 4 | 5 | 6 | 7 | 8 | 9 | 0 | 1 | 2 |
| 5 | 6 | 7 | 8 | 9 | 0 | 1 | 2 | 3 |
| 6 | 7 | 8 | 9 | 0 | 1 | 2 | 3 | 4 |
| 7 | 8 | 9 | 0 | 1 | 2 | 3 | 4 | 5 |
| 8 | 9 | 0 | 1 | 2 | 3 | 4 | 5 | 6 |
| 9 | 0 | 1 | 2 | 3 | 4 | 5 | 6 | 7 |
| 0 | 1 | 2 | 3 | 4 | 5 | 6 | 7 | 8 |
| 1 | 2 | 3 | 4 | 5 | 6 | 7 | 8 | 9 |
| 2 | 3 | 4 | 5 | 6 | 7 | 8 | 9 | 0 |
| 3 | 4 | 5 | 6 | 7 | 8 | 9 | 0 | 1 |
| 4 | 5 | 6 | 7 | 8 | 9 | 0 | 1 | 2 |
| 5 | 6 | 7 | 8 | 9 | 0 | 1 | 2 | 3 |
| 6 | 7 | 8 | 9 | 0 | 1 | 2 | 3 | 4 |
| 7 | 8 | 9 | 0 | 1 | 2 | 3 | 4 | 5 |
| 8 | 9 | 0 | 1 | 2 | 3 | 4 | 5 | 6 |
| 9 | 0 | 1 | 2 | 3 | 4 | 5 | 6 | 7 |
| 0 | 1 | 2 | 3 | 4 | 5 | 6 | 7 | 8 |
| 1 | 2 | 3 | 4 | 5 | 6 | 7 | 8 | 9 |
| 2 | 3 | 4 | 5 | 6 | 7 | 8 | 9 | 0 |
| 3 | 4 | 5 | 6 | 7 | 8 | 9 | 0 | 1 |
| 4 | 5 | 6 | 7 | 8 | 9 | 0 | 1 | 2 |
| 5 | 6 | 7 | 8 | 9 | 0 | 1 | 2 | 3 |
| 6 | 7 | 8 | 9 | 0 | 1 | 2 | 3 | 4 |
| 7 | 8 | 9 | 0 | 1 | 2 | 3 | 4 | 5 |
| 8 | 9 | 0 | 1 | 2 | 3 | 4 | 5 | 6 |
| 9 | 0 | 1 | 2 | 3 | 4 | 5 | 6 | 7 |
| 0 | 1 | 2 | 3 | 4 | 5 | 6 | 7 | 8 |
| 1 | 2 | 3 | 4 | 5 | 6 | 7 | 8 | 9 |
| 2 | 3 | 4 | 5 | 6 | 7 | 8 | 9 | 0 |
| 3 | 4 | 5 | 6 | 7 | 8 | 9 | 0 | 1 |
| 4 | 5 | 6 | 7 | 8 | 9 | 0 | 1 | 2 |
| 5 | 6 | 7 | 8 | 9 | 0 | 1 | 2 | 3 |
| 6 | 7 | 8 | 9 | 0 | 1 | 2 | 3 | 4 |
| 7 | 8 | 9 | 0 | 1 | 2 | 3 | 4 | 5 |
| 8 | 9 | 0 | 1 | 2 | 3 | 4 | 5 | 6 |
| 9 | 0 | 1 | 2 | 3 | 4 | 5 | 6 | 7 |
| 0 | 1 | 2 | 3 | 4 | 5 | 6 | 7 | 8 |
| 1 | 2 | 3 | 4 | 5 | 6 | 7 | 8 | 9 |
| 2 | 3 | 4 | 5 | 6 | 7 | 8 | 9 | 0 |
| 3 | 4 | 5 | 6 | 7 | 8 | 9 | 0 | 1 |
| 4 | 5 | 6 | 7 | 8 | 9 | 0 | 1 | 2 |
| 5 | 6 | 7 | 8 | 9 | 0 | 1 | 2 | 3 |
| 6 | 7 | 8 | 9 | 0 | 1 | 2 | 3 | 4 |
| 7 | 8 | 9 | 0 | 1 | 2 | 3 | 4 | 5 |
| 8 | 9 | 0 | 1 | 2 | 3 | 4 | 5 | 6 |
| 9 | 0 | 1 | 2 | 3 | 4 | 5 | 6 | 7 |
| 0 | 1 | 2 | 3 | 4 | 5 | 6 | 7 | 8 |
| 1 | 2 | 3 | 4 | 5 | 6 | 7 | 8 | 9 |
| 2 | 3 | 4 | 5 | 6 | 7 | 8 | 9 | 0 |
| 3 | 4 | 5 | 6 | 7 | 8 | 9 | 0 | 1 |
| 4 | 5 | 6 | 7 | 8 | 9 | 0 | 1 | 2 |
| 5 | 6 | 7 | 8 | 9 | 0 | 1 | 2 | 3 |
| 6 | 7 | 8 | 9 | 0 | 1 | 2 | 3 | 4 |
| 7 | 8 | 9 | 0 | 1 | 2 | 3 | 4 | 5 |
| 8 | 9 | 0 | 1 | 2 | 3 | 4 | 5 | 6 |
| 9 | 0 | 1 | 2 | 3 | 4 | 5 | 6 | 7 |
| 0 | 1 | 2 | 3 | 4 | 5 | 6 | 7 | 8 |
| 1 | 2 | 3 | 4 | 5 | 6 | 7 | 8 | 9 |
| 2 | 3 | 4 | 5 | 6 | 7 | 8 | 9 | 0 |
| 3 | 4 | 5 | 6 | 7 | 8 | 9 | 0 | 1 |
| 4 | 5 | 6 | 7 | 8 | 9 | 0 | 1 | 2 |
| 5 | 6 | 7 | 8 | 9 | 0 | 1 | 2 | 3 |
| 6 | 7 | 8 | 9 | 0 | 1 | 2 | 3 | 4 |
| 7 | 8 | 9 | 0 | 1 | 2 | 3 | 4 | 5 |
| 8 | 9 | 0 | 1 | 2 | 3 | 4 | 5 | 6 |
| 9 | 0 | 1 | 2 | 3 | 4 | 5 | 6 | 7 |
| 0 | 1 | 2 | 3 | 4 | 5 | 6 | 7 | 8 |
| 1 | 2 | 3 | 4 | 5 | 6 | 7 | 8 | 9 |
| 2 | 3 | 4 | 5 | 6 | 7 | 8 | 9 | 0 |
| 3 | 4 | | | | | | | |

Point Feature Record [POINTREC] 15

| Field | Position | Format | Description |
|-----------|----------|--------|-------------------------------------|
| REC_DESC | 01:02 | A2 | 15 |
| POINT_ID | 03:08 | I6 | Unique point record identifier |
| GEOM_ID | 09:14 | I6 | Pointer to [GEOMETRY1] record |
| NUM_ATT | 15:16 | I2 | 01 |
| ATT_ID | 17:22 | I6 | Pointer to [ATTREC] record |
| CONT_MARK | 23:23 | I1 | 0 |
| EOR | 24:24 | A1 | No further records i.e. ASCII 37 |

Record Example

15000027004804010048040%

| | 1 | 2 | 3 | 4 | 5 | 6 | 7 | 8 |
|------|------|------|------|------|------|------|------|------|
| 1 | 2 | 3 | 4 | 5 | 6 | 7 | 8 | 9 |
| 10 | 11 | 12 | 13 | 14 | 15 | 16 | 17 | 18 |
| 19 | 20 | 21 | 22 | 23 | 24 | 25 | 26 | 27 |
| 28 | 29 | 30 | 31 | 32 | 33 | 34 | 35 | 36 |
| 37 | 38 | 39 | 40 | 41 | 42 | 43 | 44 | 45 |
| 46 | 47 | 48 | 49 | 50 | 51 | 52 | 53 | 54 |
| 55 | 56 | 57 | 58 | 59 | 60 | 61 | 62 | 63 |
| 64 | 65 | 66 | 67 | 68 | 69 | 70 | 71 | 72 |
| 73 | 74 | 75 | 76 | 77 | 78 | 79 | 80 | 81 |
| 82 | 83 | 84 | 85 | 86 | 87 | 88 | 89 | 90 |
| 91 | 92 | 93 | 94 | 95 | 96 | 97 | 98 | 99 |
| 100 | 101 | 102 | 103 | 104 | 105 | 106 | 107 | 108 |
| 109 | 110 | 111 | 112 | 113 | 114 | 115 | 116 | 117 |
| 118 | 119 | 120 | 121 | 122 | 123 | 124 | 125 | 126 |
| 127 | 128 | 129 | 130 | 131 | 132 | 133 | 134 | 135 |
| 136 | 137 | 138 | 139 | 140 | 141 | 142 | 143 | 144 |
| 145 | 146 | 147 | 148 | 149 | 150 | 151 | 152 | 153 |
| 154 | 155 | 156 | 157 | 158 | 159 | 160 | 161 | 162 |
| 163 | 164 | 165 | 166 | 167 | 168 | 169 | 170 | 171 |
| 172 | 173 | 174 | 175 | 176 | 177 | 178 | 179 | 180 |
| 181 | 182 | 183 | 184 | 185 | 186 | 187 | 188 | 189 |
| 190 | 191 | 192 | 193 | 194 | 195 | 196 | 197 | 198 |
| 199 | 200 | 201 | 202 | 203 | 204 | 205 | 206 | 207 |
| 208 | 209 | 210 | 211 | 212 | 213 | 214 | 215 | 216 |
| 217 | 218 | 219 | 220 | 221 | 222 | 223 | 224 | 225 |
| 226 | 227 | 228 | 229 | 230 | 231 | 232 | 233 | 234 |
| 235 | 236 | 237 | 238 | 239 | 240 | 241 | 242 | 243 |
| 244 | 245 | 246 | 247 | 248 | 249 | 250 | 251 | 252 |
| 253 | 254 | 255 | 256 | 257 | 258 | 259 | 260 | 261 |
| 262 | 263 | 264 | 265 | 266 | 267 | 268 | 269 | 270 |
| 271 | 272 | 273 | 274 | 275 | 276 | 277 | 278 | 279 |
| 280 | 281 | 282 | 283 | 284 | 285 | 286 | 287 | 288 |
| 289 | 290 | 291 | 292 | 293 | 294 | 295 | 296 | 297 |
| 298 | 299 | 300 | 301 | 302 | 303 | 304 | 305 | 306 |
| 307 | 308 | 309 | 310 | 311 | 312 | 313 | 314 | 315 |
| 316 | 317 | 318 | 319 | 320 | 321 | 322 | 323 | 324 |
| 325 | 326 | 327 | 328 | 329 | 330 | 331 | 332 | 333 |
| 334 | 335 | 336 | 337 | 338 | 339 | 340 | 341 | 342 |
| 343 | 344 | 345 | 346 | 347 | 348 | 349 | 350 | 351 |
| 352 | 353 | 354 | 355 | 356 | 357 | 358 | 359 | 360 |
| 361 | 362 | 363 | 364 | 365 | 366 | 367 | 368 | 369 |
| 370 | 371 | 372 | 373 | 374 | 375 | 376 | 377 | 378 |
| 379 | 380 | 381 | 382 | 383 | 384 | 385 | 386 | 387 |
| 388 | 389 | 390 | 391 | 392 | 393 | 394 | 395 | 396 |
| 397 | 398 | 399 | 400 | 401 | 402 | 403 | 404 | 405 |
| 406 | 407 | 408 | 409 | 410 | 411 | 412 | 413 | 414 |
| 415 | 416 | 417 | 418 | 419 | 420 | 421 | 422 | 423 |
| 424 | 425 | 426 | 427 | 428 | 429 | 430 | 431 | 432 |
| 433 | 434 | 435 | 436 | 437 | 438 | 439 | 440 | 441 |
| 442 | 443 | 444 | 445 | 446 | 447 | 448 | 449 | 450 |
| 451 | 452 | 453 | 454 | 455 | 456 | 457 | 458 | 459 |
| 460 | 461 | 462 | 463 | 464 | 465 | 466 | 467 | 468 |
| 469 | 470 | 471 | 472 | 473 | 474 | 475 | 476 | 477 |
| 478 | 479 | 480 | 481 | 482 | 483 | 484 | 485 | 486 |
| 487 | 488 | 489 | 490 | 491 | 492 | 493 | 494 | 495 |
| 496 | 497 | 498 | 499 | 500 | 501 | 502 | 503 | 504 |
| 505 | 506 | 507 | 508 | 509 | 510 | 511 | 512 | 513 |
| 514 | 515 | 516 | 517 | 518 | 519 | 520 | 521 | 522 |
| 523 | 524 | 525 | 526 | 527 | 528 | 529 | 530 | 531 |
| 532 | 533 | 534 | 535 | 536 | 537 | 538 | 539 | 540 |
| 541 | 542 | 543 | 544 | 545 | 546 | 547 | 548 | 549 |
| 550 | 551 | 552 | 553 | 554 | 555 | 556 | 557 | 558 |
| 559 | 560 | 561 | 562 | 563 | 564 | 565 | 566 | 567 |
| 568 | 569 | 570 | 571 | 572 | 573 | 574 | 575 | 576 |
| 577 | 578 | 579 | 580 | 581 | 582 | 583 | 584 | 585 |
| 586 | 587 | 588 | 589 | 590 | 591 | 592 | 593 | 594 |
| 595 | 596 | 597 | 598 | 599 | 600 | 601 | 602 | 603 |
| 604 | 605 | 606 | 607 | 608 | 609 | 610 | 611 | 612 |
| 613 | 614 | 615 | 616 | 617 | 618 | 619 | 620 | 621 |
| 622 | 623 | 624 | 625 | 626 | 627 | 628 | 629 | 630 |
| 631 | 632 | 633 | 634 | 635 | 636 | 637 | 638 | 639 |
| 640 | 641 | 642 | 643 | 644 | 645 | 646 | 647 | 648 |
| 649 | 650 | 651 | 652 | 653 | 654 | 655 | 656 | 657 |
| 658 | 659 | 660 | 661 | 662 | 663 | 664 | 665 | 666 |
| 667 | 668 | 669 | 670 | 671 | 672 | 673 | 674 | 675 |
| 676 | 677 | 678 | 679 | 680 | 681 | 682 | 683 | 684 |
| 685 | 686 | 687 | 688 | 689 | 690 | 691 | 692 | 693 |
| 694 | 695 | 696 | 697 | 698 | 699 | 700 | 701 | 702 |
| 703 | 704 | 705 | 706 | 707 | 708 | 709 | 710 | 711 |
| 712 | 713 | 714 | 715 | 716 | 717 | 718 | 719 | 720 |
| 721 | 722 | 723 | 724 | 725 | 726 | 727 | 728 | 729 |
| 730 | 731 | 732 | 733 | 734 | 735 | 736 | 737 | 738 |
| 739 | 740 | 741 | 742 | 743 | 744 | 745 | 746 | 747 |
| 748 | 749 | 750 | 751 | 752 | 753 | 754 | 755 | 756 |
| 757 | 758 | 759 | 760 | 761 | 762 | 763 | 764 | 765 |
| 766 | 767 | 768 | 769 | 770 | 771 | 772 | 773 | 774 |
| 775 | 776 | 777 | 778 | 779 | 780 | 781 | 782 | 783 |
| 784 | 785 | 786 | 787 | 788 | 789 | 790 | 791 | 792 |
| 793 | 794 | 795 | 796 | 797 | 798 | 799 | 800 | 801 |
| 802 | 803 | 804 | 805 | 806 | 807 | 808 | 809 | 810 |
| 811 | 812 | 813 | 814 | 815 | 816 | 817 | 818 | 819 |
| 820 | 821 | 822 | 823 | 824 | 825 | 826 | 827 | 828 |
| 829 | 830 | 831 | 832 | 833 | 834 | 835 | 836 | 837 |
| 838 | 839 | 840 | 841 | 842 | 843 | 844 | 845 | 846 |
| 847 | 848 | 849 | 850 | 851 | 852 | 853 | 854 | 855 |
| 856 | 857 | 858 | 859 | 860 | 861 | 862 | 863 | 864 |
| 865 | 866 | 867 | 868 | 869 | 870 | 871 | 872 | 873 |
| 874 | 875 | 876 | 877 | 878 | 879 | 880 | 881 | 882 |
| 883 | 884 | 885 | 886 | 887 | 888 | 889 | 890 | 891 |
| 892 | 893 | 894 | 895 | 896 | 897 | 898 | 899 | 900 |
| 901 | 902 | 903 | 904 | 905 | 906 | 907 | 908 | 909 |
| 910 | 911 | 912 | 913 | 914 | 915 | 916 | 917 | 918 |
| 919 | 920 | 921 | 922 | 923 | 924 | 925 | 926 | 927 |
| 928 | 929 | 930 | 931 | 932 | 933 | 934 | 935 | 936 |
| 937 | 938 | 939 | 940 | 941 | 942 | 943 | 944 | 945 |
| 946 | 947 | 948 | 949 | 950 | 951 | 952 | 953 | 954 |
| 955 | 956 | 957 | 958 | 959 | 960 | 961 | 962 | 963 |
| 964 | 965 | 966 | 967 | 968 | 969 | 970 | 971 | 972 |
| 973 | 974 | 975 | 976 | 977 | 978 | 979 | 980 | 981 |
| 982 | 983 | 984 | 985 | 986 | 987 | 988 | 989 | 990 |
| 991 | 992 | 993 | 994 | 995 | 996 | 997 | 998 | 999 |
| 1000 | 1001 | 1002 | 1003 | 1004 | 1005 | 1006 | 1007 | 1008 |
| 1009 | 1010 | 1011 | 1012 | 1013 | 1014 | 1015 | 1016 | 1017 |
| 1018 | 1019 | 1020 | 1021 | 1022 | 1023 | 1024 | 1025 | 1026 |
| 1027 | 1028 | 1029 | 1030 | 1031 | 1032 | 1033 | 1034 | 1035 |
| 1036 | 1037 | 1038 | 1039 | 1040 | 1041 | 1042 | 1043 | 1044 |
| 1045 | 1046 | 1047 | 1048 | 1049 | 1050 | 1051 | 1052 | 1053 |
| 1054 | 1055 | 1056 | 1057 | 1058 | 1059 | 1060 | 1061 | 1062 |
| 1063 | 1064 | 1065 | 1066 | 1067 | 1068 | 1069 | 1070 | 1071 |
| 1072 | 1073 | 1074 | 1075 | 1076 | 1077 | 1078 | 1079 | 1080 |
| 1081 | 1082 | 1083 | 1084 | 1085 | 1086 | 1087 | 1088 | 1089 |
| 1090 | 1091 | 1092 | 1093 | 1094 | 1095 | 1096 | 1097 | 1098 |
| 1099 | 1100 | 1101 | 1102 | 1103 | 1104 | 1105 | 1106 | 1107 |
| 1108 | 1109 | 1110 | 1111 | 1112 | 1113 | 1114 | 1115 | 1116 |
| 1117 | 1118 | 1119 | 1120 | 1121 | 1122 | 1123 | 1124 | 1125 |
| 1126 | 1127 | 1128 | 1129 | 1130 | 1131 | 1132 | 1133 | 1134 |
| 1135 | 1136 | 1137 | 1138 | 1139 | 1140 | 1141 | 1142 | 1143 |
| 1144 | 1145 | 1146 | 1147 | 1148 | 1149 | 1150 | 1151 | 1152 |
| 1153 | 1154 | 1155 | 1156 | 1157 | 1158 | 1159 | 1160 | 1161 |
| 1162 | 1163 | 1164 | 1165 | 1166 | 1167 | 1168 | 1169 | 1170 |
| 1171 | 1172 | 1173 | 1174 | 1175 | 1176 | 1177 | 1178 | 1179 |
| 1180 | 1181 | 1182 | 1183 | 1184 | 1185 | 1186 | 1187 | 1188 |
| 1189 | 1190 | 1191 | 1192 | 1193 | 1194 | 1195 | 1196 | 1197 |
| 1198 | 1199 | 1200 | 1201 | 1202 | 1203 | 1204 | 1205 | 1206 |
| 1207 | 1208 | 1209 | 1210 | 1211 | 1212 | 1213 | 1214 | 1215 |
| 1216 | 1217 | 1218 | 1219 | 1220 | 1221 | 1222 | 1223 | 1224 |
| 1225 | 1226 | 1227 | 1228 | 1229 | 1230 | 1231 | 1232 | 1233 |
| 1234 | 1235 | 1236 | 1237 | 1238 | 1239 | 1240 | 1241 | 1242 |
| 1243 | 1244 | 1245 | 1246 | 1247 | 1248 | 1249 | 1250 | 1251 |
| 1252 | 1253 | 1254 | 1255 | 1256 | 1257 | 1258 | 1259 | 1260 |
| 1261 | 1262 | 1263 | 1264 | 1265 | 1266 | 1267 | 1268 | 1269 |
| 1270 | 1271 | 1272 | 1273 | 1274 | 1275 | 1276 | 1277 | 1278 |
| 1279 | 1280 | 1281 | 1282 | 1283 | 1284 | 1285 | 1286 | 1287 |
| 1288 | 1289 | 12 | | | | | | |

Two-Dimensional Geometry Record [GEOMETRY1] 21

GEOMETRY1 record associated with POINTREC

| Field | Position | Format | Description |
|-----------|----------|--------|-----------------------------------|
| REC_DESC | 01:02 | A2 | 21 |
| GEOM_ID | 03:08 | I6 | Unique geometry record identifier |
| GTYPE | 09:09 | I1 | Point feature |
| NUM_COORD | 10:13 | I4 | Point has 1 coordinate pair |
| X_COORD | 14:18 | I5 | X coordinate |
| Y_COORD | 19:23 | I5 | Y coordinate |
| QPLAN | 24:24 | A1 | <S> Not used |
| CONT_MARK | 25:25 | I1 | 0 No further records |
| EOR | 26:26 | A1 | % i.e. ASCII 37 |

Record Example

21000031100011564044030 0%

| | 1 | 2 | 3 | 4 | 5 | 6 | 7 | 8 |
|---|---|---|---|---|---|---|---|---|
| 1 | 2 | 3 | 4 | 5 | 6 | 7 | 8 | 9 |
| 0 | 1 | 2 | 3 | 4 | 5 | 6 | 7 | 8 |
| 1 | 2 | 3 | 4 | 5 | 6 | 7 | 8 | 9 |
| 2 | 3 | 4 | 5 | 6 | 7 | 8 | 9 | 0 |
| 3 | 4 | 5 | 6 | 7 | 8 | 9 | 0 | 1 |
| 4 | 5 | 6 | 7 | 8 | 9 | 0 | 1 | 2 |
| 5 | 6 | 7 | 8 | 9 | 0 | 1 | 2 | 3 |
| 6 | 7 | 8 | 9 | 0 | 1 | 2 | 3 | 4 |
| 7 | 8 | 9 | 0 | 1 | 2 | 3 | 4 | 5 |
| 8 | 9 | 0 | 1 | 2 | 3 | 4 | 5 | 6 |
| 9 | 0 | 1 | 2 | 3 | 4 | 5 | 6 | 7 |
| 0 | 1 | 2 | 3 | 4 | 5 | 6 | 7 | 8 |
| 1 | 2 | 3 | 4 | 5 | 6 | 7 | 8 | 9 |
| 2 | 3 | 4 | 5 | 6 | 7 | 8 | 9 | 0 |
| 3 | 4 | 5 | 6 | 7 | 8 | 9 | 0 | 1 |
| 4 | 5 | 6 | 7 | 8 | 9 | 0 | 1 | 2 |
| 5 | 6 | 7 | 8 | 9 | 0 | 1 | 2 | 3 |
| 6 | 7 | 8 | 9 | 0 | 1 | 2 | 3 | 4 |
| 7 | 8 | 9 | 0 | 1 | 2 | 3 | 4 | 5 |
| 8 | 9 | 0 | 1 | 2 | 3 | 4 | 5 | 6 |
| 9 | 0 | 1 | 2 | 3 | 4 | 5 | 6 | 7 |
| 0 | 1 | 2 | 3 | 4 | 5 | 6 | 7 | 8 |
| 1 | 2 | 3 | 4 | 5 | 6 | 7 | 8 | 9 |
| 2 | 3 | 4 | 5 | 6 | 7 | 8 | 9 | 0 |
| 3 | 4 | 5 | 6 | 7 | 8 | 9 | 0 | 1 |
| 4 | 5 | 6 | 7 | 8 | 9 | 0 | 1 | 2 |
| 5 | 6 | 7 | 8 | 9 | 0 | 1 | 2 | 3 |
| 6 | 7 | 8 | 9 | 0 | 1 | 2 | 3 | 4 |
| 7 | 8 | 9 | 0 | 1 | 2 | 3 | 4 | 5 |
| 8 | 9 | 0 | 1 | 2 | 3 | 4 | 5 | 6 |
| 9 | 0 | 1 | 2 | 3 | 4 | 5 | 6 | 7 |
| 0 | 1 | 2 | 3 | 4 | 5 | 6 | 7 | 8 |
| 1 | 2 | 3 | 4 | 5 | 6 | 7 | 8 | 9 |
| 2 | 3 | 4 | 5 | 6 | 7 | 8 | 9 | 0 |
| 3 | 4 | 5 | 6 | 7 | 8 | 9 | 0 | 1 |
| 4 | 5 | 6 | 7 | 8 | 9 | 0 | 1 | 2 |
| 5 | 6 | 7 | 8 | 9 | 0 | 1 | 2 | 3 |
| 6 | 7 | 8 | 9 | 0 | 1 | 2 | 3 | 4 |
| 7 | 8 | 9 | 0 | 1 | 2 | 3 | 4 | 5 |
| 8 | 9 | 0 | 1 | 2 | 3 | 4 | 5 | 6 |
| 9 | 0 | 1 | 2 | 3 | 4 | 5 | 6 | 7 |
| 0 | 1 | 2 | 3 | 4 | 5 | 6 | 7 | 8 |
| 1 | 2 | 3 | 4 | 5 | 6 | 7 | 8 | 9 |
| 2 | 3 | 4 | 5 | 6 | 7 | 8 | 9 | 0 |
| 3 | 4 | 5 | 6 | 7 | 8 | 9 | 0 | 1 |
| 4 | 5 | 6 | 7 | 8 | 9 | 0 | 1 | 2 |
| 5 | 6 | 7 | 8 | 9 | 0 | 1 | 2 | 3 |
| 6 | 7 | 8 | 9 | 0 | 1 | 2 | 3 | 4 |
| 7 | 8 | 9 | 0 | 1 | 2 | 3 | 4 | 5 |
| 8 | 9 | 0 | 1 | 2 | 3 | 4 | 5 | 6 |
| 9 | 0 | 1 | 2 | 3 | 4 | 5 | 6 | 7 |
| 0 | 1 | 2 | 3 | 4 | 5 | 6 | 7 | 8 |
| 1 | 2 | 3 | 4 | 5 | 6 | 7 | 8 | 9 |
| 2 | 3 | 4 | 5 | 6 | 7 | 8 | 9 | 0 |
| 3 | 4 | 5 | 6 | 7 | 8 | 9 | 0 | 1 |
| 4 | 5 | 6 | 7 | 8 | 9 | 0 | 1 | 2 |
| 5 | 6 | 7 | 8 | 9 | 0 | 1 | 2 | 3 |
| 6 | 7 | 8 | 9 | 0 | 1 | 2 | 3 | 4 |
| 7 | 8 | 9 | 0 | 1 | 2 | 3 | 4 | 5 |
| 8 | 9 | 0 | 1 | 2 | 3 | 4 | 5 | 6 |
| 9 | 0 | 1 | 2 | 3 | 4 | 5 | 6 | 7 |
| 0 | 1 | 2 | 3 | 4 | 5 | 6 | 7 | 8 |
| 1 | 2 | 3 | 4 | 5 | 6 | 7 | 8 | 9 |
| 2 | 3 | 4 | 5 | 6 | 7 | 8 | 9 | 0 |
| 3 | 4 | 5 | 6 | 7 | 8 | 9 | 0 | 1 |
| 4 | 5 | 6 | 7 | 8 | 9 | 0 | 1 | 2 |
| 5 | 6 | 7 | 8 | 9 | 0 | 1 | 2 | 3 |
| 6 | 7 | 8 | 9 | 0 | 1 | 2 | 3 | 4 |
| 7 | 8 | 9 | 0 | 1 | 2 | 3 | 4 | 5 |
| 8 | 9 | 0 | 1 | 2 | 3 | 4 | 5 | 6 |
| 9 | 0 | 1 | 2 | 3 | 4 | 5 | 6 | 7 |
| 0 | 1 | 2 | 3 | 4 | 5 | 6 | 7 | 8 |
| 1 | 2 | 3 | 4 | 5 | 6 | 7 | 8 | 9 |
| 2 | 3 | 4 | 5 | 6 | 7 | 8 | 9 | 0 |
| 3 | 4 | 5 | 6 | 7 | 8 | 9 | 0 | 1 |
| 4 | 5 | 6 | 7 | 8 | 9 | 0 | 1 | 2 |
| 5 | 6 | 7 | 8 | 9 | 0 | 1 | 2 | 3 |
| 6 | 7 | 8 | 9 | 0 | 1 | 2 | 3 | 4 |
| 7 | 8 | 9 | 0 | 1 | 2 | 3 | 4 | 5 |
| 8 | 9 | 0 | 1 | 2 | 3 | 4 | 5 | 6 |
| 9 | 0 | 1 | 2 | 3 | 4 | 5 | 6 | 7 |
| 0 | 1 | 2 | 3 | 4 | 5 | 6 | 7 | 8 |
| 1 | 2 | 3 | 4 | 5 | 6 | 7 | 8 | 9 |
| 2 | 3 | 4 | 5 | 6 | 7 | 8 | 9 | 0 |
| 3 | 4 | 5 | 6 | 7 | 8 | 9 | 0 | 1 |
| 4 | 5 | 6 | 7 | 8 | 9 | 0 | 1 | 2 |
| 5 | 6 | 7 | 8 | 9 | 0 | 1 | 2 | 3 |
| 6 | 7 | 8 | 9 | 0 | 1 | 2 | 3 | 4 |
| 7 | 8 | 9 | 0 | 1 | 2 | 3 | 4 | 5 |
| 8 | 9 | 0 | 1 | 2 | 3 | 4 | 5 | 6 |
| 9 | 0 | 1 | 2 | 3 | 4 | 5 | 6 | 7 |
| 0 | 1 | 2 | 3 | 4 | 5 | 6 | 7 | 8 |
| 1 | 2 | 3 | 4 | 5 | 6 | 7 | 8 | 9 |
| 2 | 3 | 4 | 5 | 6 | 7 | 8 | 9 | 0 |
| 3 | 4 | 5 | 6 | 7 | 8 | 9 | 0 | 1 |
| 4 | 5 | 6 | 7 | 8 | 9 | 0 | 1 | 2 |
| 5 | 6 | 7 | 8 | 9 | 0 | 1 | 2 | 3 |
| 6 | 7 | 8 | 9 | 0 | 1 | 2 | 3 | 4 |
| 7 | 8 | 9 | 0 | 1 | 2 | 3 | 4 | 5 |
| 8 | 9 | 0 | 1 | 2 | 3 | 4 | 5 | 6 |
| 9 | 0 | 1 | 2 | 3 | 4 | 5 | 6 | 7 |
| 0 | 1 | 2 | 3 | 4 | 5 | 6 | 7 | 8 |
| 1 | 2 | 3 | 4 | 5 | 6 | 7 | 8 | 9 |
| 2 | 3 | 4 | 5 | 6 | 7 | 8 | 9 | 0 |
| 3 | 4 | 5 | 6 | 7 | 8 | 9 | 0 | 1 |
| 4 | 5 | 6 | 7 | 8 | 9 | 0 | 1 | 2 |
| 5 | 6 | 7 | 8 | 9 | 0 | 1 | 2 | 3 |
| 6 | 7 | 8 | 9 | 0 | 1 | 2 | 3 | 4 |
| 7 | 8 | 9 | 0 | 1 | 2 | 3 | 4 | 5 |
| 8 | 9 | 0 | 1 | 2 | 3 | 4 | 5 | 6 |
| 9 | 0 | 1 | 2 | 3 | 4 | 5 | 6 | 7 |
| 0 | 1 | 2 | 3 | 4 | 5 | 6 | 7 | 8 |
| 1 | 2 | 3 | 4 | 5 | 6 | 7 | 8 | 9 |
| 2 | 3 | 4 | 5 | 6 | 7 | 8 | 9 | 0 |
| 3 | 4 | 5 | 6 | 7 | 8 | 9 | 0 | 1 |
| 4 | 5 | 6 | 7 | 8 | 9 | 0 | 1 | 2 |
| 5 | 6 | 7 | 8 | 9 | 0 | 1 | 2 | 3 |
| 6 | 7 | 8 | 9 | 0 | 1 | 2 | 3 | 4 |
| 7 | 8 | 9 | 0 | 1 | 2 | 3 | 4 | 5 |
| 8 | 9 | 0 | 1 | 2 | 3 | 4 | 5 | 6 |
| 9 | 0 | 1 | 2 | 3 | 4 | 5 | 6 | 7 |
| 0 | 1 | 2 | 3 | 4 | 5 | 6 | 7 | 8 |
| 1 | 2 | 3 | 4 | 5 | 6 | 7 | 8 | 9 |
| 2 | 3 | 4 | 5 | 6 | 7 | 8 | 9 | 0 |
| 3 | 4 | 5 | 6 | 7 | 8 | 9 | 0 | 1 |
| 4 | 5 | 6 | 7 | 8 | 9 | 0 | 1 | 2 |
| 5 | 6 | 7 | 8 | 9 | 0 | 1 | 2 | 3 |
| 6 | 7 | 8 | 9 | 0 | 1 | 2 | 3 | 4 |
| 7 | 8 | 9 | 0 | 1 | 2 | 3 | 4 | 5 |
| 8 | 9 | 0 | 1 | 2 | 3 | 4 | 5 | 6 |
| 9 | 0 | 1 | 2 | 3 | 4 | 5 | 6 | 7 |
| 0 | 1 | 2 | 3 | 4 | 5 | 6 | 7 | 8 |
| 1 | 2 | 3 | 4 | 5 | 6 | 7 | 8 | 9 |
| 2 | 3 | 4 | 5 | 6 | 7 | 8 | 9 | 0 |
| 3 | 4 | 5 | 6 | 7 | 8 | 9 | 0 | 1 |
| 4 | 5 | 6 | 7 | 8 | 9 | 0 | 1 | 2 |
| 5 | 6 | 7 | 8 | 9 | 0 | 1 | 2 | 3 |
| 6 | 7 | 8 | 9 | 0 | 1 | 2 | 3 | 4 |
| 7 | 8 | 9 | 0 | 1 | 2 | 3 | 4 | 5 |
| 8 | 9 | 0 | 1 | 2 | 3 | 4 | 5 | 6 |
| 9 | 0 | 1 | 2 | 3 | 4 | 5 | 6 | 7 |
| 0 | 1 | 2 | 3 | 4 | 5 | 6 | 7 | 8 |
| 1 | 2 | 3 | 4 | 5 | 6 | 7 | 8 | 9 |
| 2 | 3 | 4 | 5 | 6 | 7 | 8 | 9 | 0 |
| 3 | 4 | 5 | 6 | 7 | 8 | 9 | 0 | 1 |
| 4 | 5 | 6 | 7 | 8 | 9 | 0 | 1 | 2 |
| 5 | 6 | 7 | 8 | 9 | 0 | 1 | 2 | 3 |
| 6 | 7 | 8 | 9 | 0 | 1 | 2 | 3 | 4 |
| 7 | 8 | 9 | 0 | 1 | 2 | 3 | 4 | 5 |
| 8 | 9 | 0 | 1 | 2 | 3 | 4 | 5 | 6 |
| 9 | 0 | 1 | 2 | 3 | 4 | 5 | 6 | 7 |
| 0 | 1 | 2 | 3 | 4 | 5 | 6 | 7 | 8 |
| 1 | 2 | 3 | 4 | 5 | 6 | 7 | 8 | 9 |
| 2 | 3 | 4 | 5 | 6 | 7 | 8 | 9 | 0 |
| 3 | 4 | 5 | 6 | 7 | 8 | 9 | 0 | 1 |
| 4 | 5 | 6 | 7 | 8 | 9 | 0 | 1 | 2 |
| 5 | 6 | 7 | 8 | 9 | 0 | 1 | 2 | 3 |
| 6 | 7 | 8 | 9 | 0 | 1 | 2 | 3 | 4 |
| 7 | 8 | 9 | 0 | 1 | 2 | 3 | 4 | 5 |
| 8 | 9 | 0 | 1 | 2 | 3 | 4 | 5 | 6 |
| 9 | 0 | 1 | 2 | 3 | 4 | 5 | 6 | 7 |
| 0 | 1 | 2 | 3 | 4 | 5 | 6 | 7 | 8 |
| 1 | 2 | 3 | 4 | 5 | 6 | 7 | 8 | 9 |
| 2 | 3 | 4 | 5 | | | | | |

GEOMETRY1 record associated with LINEREC

| <u>Field</u> | <u>Position</u> | <u>Format</u> | <u>Description</u> |
|--------------|-----------------|---------------|--|
| REC_DESC | 01:02 | A2 | 21 |
| GEOM_ID | 03:08 | I6 | Unique geometry record identifier |
| GTYPE | 09:09 | I1 | 2 Line feature |
| NUM_COORD | 10:13 | I4 | Number of coord pairs, in range 0002-9999 |
| X_COORD | 14:18 | I5 | X coordinate} (Repeated until {NUM_COORD}) |
| Y_COORD | 19:23 | I5 | Y coordinate} (has been transferred) |
| IQPLAN | 24:24 | A1 | <S> Not used |
| CONT_MARK | ** | I1 | 0 or 1 1 if followed by continuation record |
| EOR | ** | A1 | % i.e. ASCII 37 |

* = variable

Note: this record may contain many CONTINUATION 00 records.

Line Feature Record [LINEREC] 23

| Field | Position | Format | Description |
|-----------|----------|--------|-------------------------------------|
| REC_DESC | 01:02 | A2 | 23 |
| LINE_ID | 03:08 | I6 | Unique line record identifier |
| GEOM_ID | 09:14 | I6 | Pointer to [GEOMETRY1] record |
| NUM_ATT | 15:16 | I2 | 01 |
| ATT_ID | 17:22 | I6 | Pointer to [ATTREC] record |
| CONT_MARK | 23:23 | I1 | 0 |
| EOR | 24:24 | A1 | No further records i.e. ASCII 37 |

Record Example

23004804005369010053690%

| | 1 | 2 | 3 | 4 | 5 | 6 | 7 | 8 |
|------|------|------|------|------|------|------|------|------|
| 1 | 2 | 3 | 4 | 5 | 6 | 7 | 8 | 9 |
| 10 | 11 | 12 | 13 | 14 | 15 | 16 | 17 | 18 |
| 19 | 20 | 21 | 22 | 23 | 24 | 25 | 26 | 27 |
| 28 | 29 | 30 | 31 | 32 | 33 | 34 | 35 | 36 |
| 37 | 38 | 39 | 40 | 41 | 42 | 43 | 44 | 45 |
| 46 | 47 | 48 | 49 | 50 | 51 | 52 | 53 | 54 |
| 55 | 56 | 57 | 58 | 59 | 60 | 61 | 62 | 63 |
| 64 | 65 | 66 | 67 | 68 | 69 | 70 | 71 | 72 |
| 73 | 74 | 75 | 76 | 77 | 78 | 79 | 80 | 81 |
| 82 | 83 | 84 | 85 | 86 | 87 | 88 | 89 | 90 |
| 91 | 92 | 93 | 94 | 95 | 96 | 97 | 98 | 99 |
| 100 | 101 | 102 | 103 | 104 | 105 | 106 | 107 | 108 |
| 109 | 110 | 111 | 112 | 113 | 114 | 115 | 116 | 117 |
| 118 | 119 | 120 | 121 | 122 | 123 | 124 | 125 | 126 |
| 127 | 128 | 129 | 130 | 131 | 132 | 133 | 134 | 135 |
| 136 | 137 | 138 | 139 | 140 | 141 | 142 | 143 | 144 |
| 145 | 146 | 147 | 148 | 149 | 150 | 151 | 152 | 153 |
| 154 | 155 | 156 | 157 | 158 | 159 | 160 | 161 | 162 |
| 163 | 164 | 165 | 166 | 167 | 168 | 169 | 170 | 171 |
| 172 | 173 | 174 | 175 | 176 | 177 | 178 | 179 | 180 |
| 181 | 182 | 183 | 184 | 185 | 186 | 187 | 188 | 189 |
| 190 | 191 | 192 | 193 | 194 | 195 | 196 | 197 | 198 |
| 199 | 200 | 201 | 202 | 203 | 204 | 205 | 206 | 207 |
| 208 | 209 | 210 | 211 | 212 | 213 | 214 | 215 | 216 |
| 217 | 218 | 219 | 220 | 221 | 222 | 223 | 224 | 225 |
| 226 | 227 | 228 | 229 | 230 | 231 | 232 | 233 | 234 |
| 235 | 236 | 237 | 238 | 239 | 240 | 241 | 242 | 243 |
| 244 | 245 | 246 | 247 | 248 | 249 | 250 | 251 | 252 |
| 253 | 254 | 255 | 256 | 257 | 258 | 259 | 260 | 261 |
| 262 | 263 | 264 | 265 | 266 | 267 | 268 | 269 | 270 |
| 271 | 272 | 273 | 274 | 275 | 276 | 277 | 278 | 279 |
| 280 | 281 | 282 | 283 | 284 | 285 | 286 | 287 | 288 |
| 289 | 290 | 291 | 292 | 293 | 294 | 295 | 296 | 297 |
| 298 | 299 | 300 | 301 | 302 | 303 | 304 | 305 | 306 |
| 307 | 308 | 309 | 310 | 311 | 312 | 313 | 314 | 315 |
| 316 | 317 | 318 | 319 | 320 | 321 | 322 | 323 | 324 |
| 325 | 326 | 327 | 328 | 329 | 330 | 331 | 332 | 333 |
| 334 | 335 | 336 | 337 | 338 | 339 | 340 | 341 | 342 |
| 343 | 344 | 345 | 346 | 347 | 348 | 349 | 350 | 351 |
| 352 | 353 | 354 | 355 | 356 | 357 | 358 | 359 | 360 |
| 361 | 362 | 363 | 364 | 365 | 366 | 367 | 368 | 369 |
| 370 | 371 | 372 | 373 | 374 | 375 | 376 | 377 | 378 |
| 379 | 380 | 381 | 382 | 383 | 384 | 385 | 386 | 387 |
| 388 | 389 | 390 | 391 | 392 | 393 | 394 | 395 | 396 |
| 397 | 398 | 399 | 400 | 401 | 402 | 403 | 404 | 405 |
| 406 | 407 | 408 | 409 | 410 | 411 | 412 | 413 | 414 |
| 415 | 416 | 417 | 418 | 419 | 420 | 421 | 422 | 423 |
| 424 | 425 | 426 | 427 | 428 | 429 | 430 | 431 | 432 |
| 433 | 434 | 435 | 436 | 437 | 438 | 439 | 440 | 441 |
| 442 | 443 | 444 | 445 | 446 | 447 | 448 | 449 | 450 |
| 451 | 452 | 453 | 454 | 455 | 456 | 457 | 458 | 459 |
| 460 | 461 | 462 | 463 | 464 | 465 | 466 | 467 | 468 |
| 469 | 470 | 471 | 472 | 473 | 474 | 475 | 476 | 477 |
| 478 | 479 | 480 | 481 | 482 | 483 | 484 | 485 | 486 |
| 487 | 488 | 489 | 490 | 491 | 492 | 493 | 494 | 495 |
| 496 | 497 | 498 | 499 | 500 | 501 | 502 | 503 | 504 |
| 505 | 506 | 507 | 508 | 509 | 510 | 511 | 512 | 513 |
| 514 | 515 | 516 | 517 | 518 | 519 | 520 | 521 | 522 |
| 523 | 524 | 525 | 526 | 527 | 528 | 529 | 530 | 531 |
| 532 | 533 | 534 | 535 | 536 | 537 | 538 | 539 | 540 |
| 541 | 542 | 543 | 544 | 545 | 546 | 547 | 548 | 549 |
| 550 | 551 | 552 | 553 | 554 | 555 | 556 | 557 | 558 |
| 559 | 560 | 561 | 562 | 563 | 564 | 565 | 566 | 567 |
| 568 | 569 | 570 | 571 | 572 | 573 | 574 | 575 | 576 |
| 577 | 578 | 579 | 580 | 581 | 582 | 583 | 584 | 585 |
| 586 | 587 | 588 | 589 | 590 | 591 | 592 | 593 | 594 |
| 595 | 596 | 597 | 598 | 599 | 600 | 601 | 602 | 603 |
| 604 | 605 | 606 | 607 | 608 | 609 | 610 | 611 | 612 |
| 613 | 614 | 615 | 616 | 617 | 618 | 619 | 620 | 621 |
| 622 | 623 | 624 | 625 | 626 | 627 | 628 | 629 | 630 |
| 631 | 632 | 633 | 634 | 635 | 636 | 637 | 638 | 639 |
| 640 | 641 | 642 | 643 | 644 | 645 | 646 | 647 | 648 |
| 649 | 650 | 651 | 652 | 653 | 654 | 655 | 656 | 657 |
| 658 | 659 | 660 | 661 | 662 | 663 | 664 | 665 | 666 |
| 667 | 668 | 669 | 670 | 671 | 672 | 673 | 674 | 675 |
| 676 | 677 | 678 | 679 | 680 | 681 | 682 | 683 | 684 |
| 685 | 686 | 687 | 688 | 689 | 690 | 691 | 692 | 693 |
| 694 | 695 | 696 | 697 | 698 | 699 | 700 | 701 | 702 |
| 703 | 704 | 705 | 706 | 707 | 708 | 709 | 710 | 711 |
| 712 | 713 | 714 | 715 | 716 | 717 | 718 | 719 | 720 |
| 721 | 722 | 723 | 724 | 725 | 726 | 727 | 728 | 729 |
| 730 | 731 | 732 | 733 | 734 | 735 | 736 | 737 | 738 |
| 739 | 740 | 741 | 742 | 743 | 744 | 745 | 746 | 747 |
| 748 | 749 | 750 | 751 | 752 | 753 | 754 | 755 | 756 |
| 757 | 758 | 759 | 760 | 761 | 762 | 763 | 764 | 765 |
| 766 | 767 | 768 | 769 | 770 | 771 | 772 | 773 | 774 |
| 775 | 776 | 777 | 778 | 779 | 780 | 781 | 782 | 783 |
| 784 | 785 | 786 | 787 | 788 | 789 | 790 | 791 | 792 |
| 793 | 794 | 795 | 796 | 797 | 798 | 799 | 800 | 801 |
| 802 | 803 | 804 | 805 | 806 | 807 | 808 | 809 | 810 |
| 811 | 812 | 813 | 814 | 815 | 816 | 817 | 818 | 819 |
| 820 | 821 | 822 | 823 | 824 | 825 | 826 | 827 | 828 |
| 829 | 830 | 831 | 832 | 833 | 834 | 835 | 836 | 837 |
| 838 | 839 | 840 | 841 | 842 | 843 | 844 | 845 | 846 |
| 847 | 848 | 849 | 850 | 851 | 852 | 853 | 854 | 855 |
| 856 | 857 | 858 | 859 | 860 | 861 | 862 | 863 | 864 |
| 865 | 866 | 867 | 868 | 869 | 870 | 871 | 872 | 873 |
| 874 | 875 | 876 | 877 | 878 | 879 | 880 | 881 | 882 |
| 883 | 884 | 885 | 886 | 887 | 888 | 889 | 890 | 891 |
| 892 | 893 | 894 | 895 | 896 | 897 | 898 | 899 | 900 |
| 901 | 902 | 903 | 904 | 905 | 906 | 907 | 908 | 909 |
| 910 | 911 | 912 | 913 | 914 | 915 | 916 | 917 | 918 |
| 919 | 920 | 921 | 922 | 923 | 924 | 925 | 926 | 927 |
| 928 | 929 | 930 | 931 | 932 | 933 | 934 | 935 | 936 |
| 937 | 938 | 939 | 940 | 941 | 942 | 943 | 944 | 945 |
| 946 | 947 | 948 | 949 | 950 | 951 | 952 | 953 | 954 |
| 955 | 956 | 957 | 958 | 959 | 960 | 961 | 962 | 963 |
| 964 | 965 | 966 | 967 | 968 | 969 | 970 | 971 | 972 |
| 973 | 974 | 975 | 976 | 977 | 978 | 979 | 980 | 981 |
| 982 | 983 | 984 | 985 | 986 | 987 | 988 | 989 | 990 |
| 991 | 992 | 993 | 994 | 995 | 996 | 997 | 998 | 999 |
| 1000 | 1001 | 1002 | 1003 | 1004 | 1005 | 1006 | 1007 | 1008 |
| 1009 | 1010 | 1011 | 1012 | 1013 | 1014 | 1015 | 1016 | 1017 |
| 1018 | 1019 | 1020 | 1021 | 1022 | 1023 | 1024 | 1025 | 1026 |
| 1027 | 1028 | 1029 | 1030 | 1031 | 1032 | 1033 | 1034 | 1035 |
| 1036 | 1037 | 1038 | 1039 | 1040 | 1041 | 1042 | 1043 | 1044 |
| 1045 | 1046 | 1047 | 1048 | 1049 | 1050 | 1051 | 1052 | 1053 |
| 1054 | 1055 | 1056 | 1057 | 1058 | 1059 | 1060 | 1061 | 1062 |
| 1063 | 1064 | 1065 | 1066 | 1067 | 1068 | 1069 | 1070 | 1071 |
| 1072 | 1073 | 1074 | 1075 | 1076 | 1077 | 1078 | 1079 | 1080 |
| 1081 | 1082 | 1083 | 1084 | 1085 | 1086 | 1087 | 1088 | 1089 |
| 1090 | 1091 | 1092 | 1093 | 1094 | 1095 | 1096 | 1097 | 1098 |
| 1099 | 1100 | 1101 | 1102 | 1103 | 1104 | 1105 | 1106 | 1107 |
| 1108 | 1109 | 1110 | 1111 | 1112 | 1113 | 1114 | 1115 | 1116 |
| 1117 | 1118 | 1119 | 1120 | 1121 | 1122 | 1123 | 1124 | 1125 |
| 1126 | 1127 | 1128 | 1129 | 1130 | 1131 | 1132 | 1133 | 1134 |
| 1135 | 1136 | 1137 | 1138 | 1139 | 1140 | 1141 | 1142 | 1143 |
| 1144 | 1145 | 1146 | 1147 | 1148 | 1149 | 1150 | 1151 | 1152 |
| 1153 | 1154 | 1155 | 1156 | 1157 | 1158 | 1159 | 1160 | 1161 |
| 1162 | 1163 | 1164 | 1165 | 1166 | 1167 | 1168 | 1169 | 1170 |
| 1171 | 1172 | 1173 | 1174 | 1175 | 1176 | 117 | | |

Attribute Description Record [ATTDESC] 40

| <u>Field</u> | <u>Position</u> | <u>Format</u> | <u>Description</u> | |
|--------------|-----------------|---------------|-----------------------|----------------------------|
| REC_DESC | 01:02 | A2 | 40 | |
| VAL_TYPE | 03:04 | A2 | Attribute mnemonic | |
| FWIDTH | 05:07 | A3 | 001-999 <3S> | if fixed or if variable |
| FINTER | 08:12 | A5 | format desc A* | if fixed or if variable |
| ATTNAME | 13:* | A* | Attribute name | see below |
| DIVIDER | ** | A1 | \ | |
| FDESC | ** | A* | Attribute description | see below |
| DIVIDER | ** | A1 | \ | |
| CONT_MARK | ** | I1 | 0 | No further records |

* = variable

Record Example (of all valid contents of ATTDASC for Meridian product)

```

40FC004I4 FEATURE CODE\NUMERIC FEATURE CODE\0%
40OM013A13 OSMDR\ORDNANCE SURVEY MERIDIAN DATA REFERENCE\0%
40RN A* ROAD NUMBER\DOT ROUTE NUMBER\0%
40TR001A1 TRUNK ROAD\TRUNK ROAD INDICATOR\0%
40RT001A1 ROUNDABOUT\ROUNDABOUT INDICATOR\0%
40JN A* JUNCTION NAME\JUNCTION NAME\0%
40LC006I6 LEFT COUNTY\LEFT COUNTY INDICATOR\0%
40RC006I6 RIGHT COUNTY\RIGHT COUNTY INDICATOR\0%
40LD006I6 LEFT DISTRICT\LEFT DISTRICT INDICATOR\0%
40RD006I6 RIGHT DISTRICT\RIGHT DISTRICT INDICATOR\0%
40NM A* ADMIN NAME\ADMINISTRATIVE AREA NAME\0%
40PI006I6 GLOBAL ID\ADMIN AREA GLOBAL IDENTIFIER\0%
40DA006A13 DLUA ID\DLUA IDENTIFIER\0%
40PN A* PROPER NAME\DEFINITIVE NAME\0%
40RI006A13 RAIL ID\RAILWAY IDENTIFIER\0%
40SI006A13 STATION ID\STATION IDENTIFIER\0%
40TX A* TEXT\INDEPENDENT TEXT\0%

```

| | | | | | | | | |
|---|---|---|---|---|---|---|---|---|
| | 1 | 2 | 3 | 4 | 5 | 6 | 7 | 8 |
| 1 | 2 | 3 | 4 | 5 | 6 | 7 | 8 | 9 |
| 0 | 1 | 2 | 3 | 4 | 5 | 6 | 7 | 8 |
| 9 | 0 | 1 | 2 | 3 | 4 | 5 | 6 | 7 |
| 8 | 9 | 0 | 1 | 2 | 3 | 4 | 5 | 6 |
| 7 | 8 | 9 | 0 | 1 | 2 | 3 | 4 | 5 |
| 6 | 7 | 8 | 9 | 0 | 1 | 2 | 3 | 4 |
| 5 | 6 | 7 | 8 | 9 | 0 | 1 | 2 | 3 |
| 4 | 5 | 6 | 7 | 8 | 9 | 0 | 1 | 2 |
| 3 | 4 | 5 | 6 | 7 | 8 | 9 | 0 | 1 |
| 2 | 3 | 4 | 5 | 6 | 7 | 8 | 9 | 0 |
| 1 | 2 | 3 | 4 | 5 | 6 | 7 | 8 | 9 |
| 0 | 1 | 2 | 3 | 4 | 5 | 6 | 7 | 8 |

Template

Text Record [TEXTREC] 43

| Field | Position | Format | Description |
|-----------|----------|--------|-------------------------------------|
| REC_DESC | 01:02 | A2 | 43 |
| TEXT_ID | 03:08 | I6 | Unique text record identifier |
| NUM_SEL | 09:10 | I2 | 01 |
| SELECT | 11:12 | A2 | 00 |
| TEXT_CODE | 13:16 | A4 | 0000 |
| TEXP_ID | 17:22 | I6 | Pointer to [TEXTPOS] record |
| NUM_ATT | 23:24 | I2 | 01 |
| ATT_ID | 25:30 | I6 | Pointer to [ATTREC] record |
| CONT_MARK | 31:31 | I1 | 0 |
| EOR | 32:32 | A1 | No further records i.e. ASCII 37 |

Record Example

4300000701000000000007010002670%

| | 1 | 2 | 3 | 4 | 5 | 6 | 7 | 8 |
|------------|------------|------------|------------|------------|------------|------------|------------|------------|
| 1234567890 | 1234567890 | 1234567890 | 1234567890 | 1234567890 | 1234567890 | 1234567890 | 1234567890 | 1234567890 |

Template

Volume Terminator Record [VOLTERM] 99

| Field | Position | Format | Description |
|-----------|----------|--------|--|
| REC_DESC | 01:02 | A2 | 99 |
| FREE_TEXT | 03:* | A* | See note below |
| CONT_VOL | *.* | I1 | 0 or 1 1 if followed by Continuation Volume |
| EOR | *.* | A1 | % i.e. ASCII 37 |

Notes: If there are further Volume(s) to follow then the FREE_TEXT field comprises the following message:
'End Of Volume (nn). Transfer Set Continues On Volume (nn+1)'

If there are no further Volumes then the FREE_TEXT field will READ:
'End Of Transfer Set'

* = variable

Record Example

```
99End Of Volume 01 Transfer Set Continues On Volume 02 1%
99End Of Transfer Set0%
```

| | 1 | 2 | 3 | 4 | 5 | 6 | 7 | 8 |
|------------|------------|------------|------------|------------|------------|------------|------------|------------|
| 1234567890 | 1234567890 | 1234567890 | 1234567890 | 1234567890 | 1234567890 | 1234567890 | 1234567890 | 1234567890 |

Template

Appendix B DXF File Structure for Meridian

General

The following paragraphs describe the DXF group and section structure for the transfer of Meridian.

It is assumed that the reader of this Appendix is familiar with Appendix C of the AutoCAD reference manual, which is published by Autodesk Ltd, Cross Lane, GUILDFORD GU1 1UJ, or an equivalent document published by the reader's software supplier if a CAD package other than AutoCAD is to be used.

Meridian DXF files containing Ordnance Survey data can be very large and so are supplied on CD-ROM media only

The following section gives a detailed breakdown of the data structure of Meridian in DXF.

This is a two stage procedure which consists of:

1. Diagrammatic view of the Data Structure with a preceding outline description of that part of the data structure
2. Detailed examples of the record sequence and contents of the data structure. A diagram of the Record Group precedes each example.

Data Structure

The following diagrams (Figures B.1 - B.14) represent the data structure of DXF. Where one element of a figure is the starting point for another figure, this is indicated beneath the relevant box.

For details of the specification for the DXF 'group' see Appendix C of the AutoCAD Reference Manual.

Figure B.1: Level 1

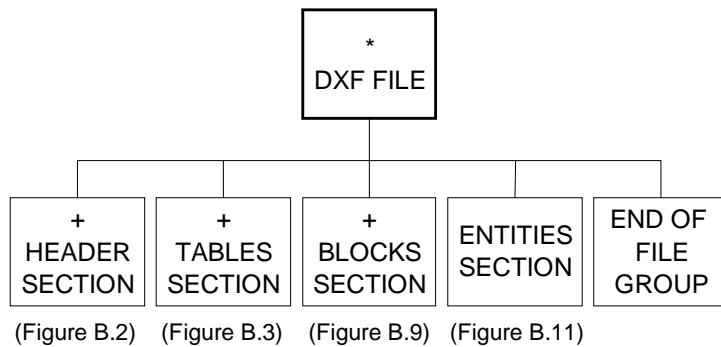

Key:

* = One or more

+ = Optional

Header

The header will be constructed as follows, with only those fields being supplied.

Figure B.2: Level 2

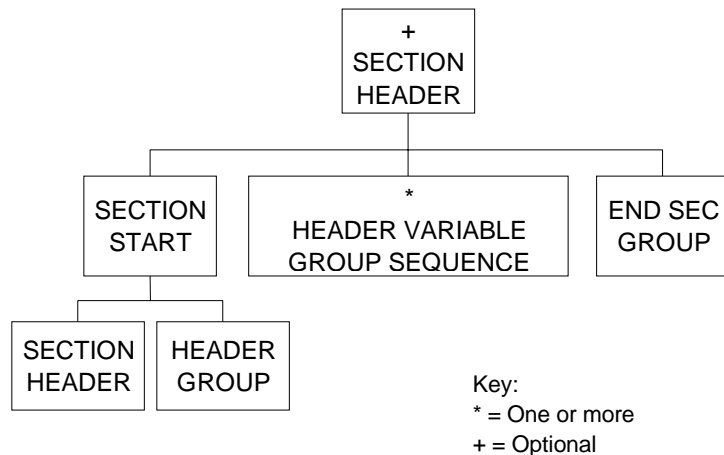

The header must be structured in the following order.

| | |
|--------------|--|
| 0 | |
| SECTION | |
| 2 | |
| HEADER | |
| 9 | |
| \$ACADVER | AutoCAD drawing database version number |
| 1 | |
| AC1009 | This indicates Release 11 or 12 (not 9) |
| 9 | |
| \$EXTMIN | X and Y drawing extents, lower left corner |
| 10 | |
| nnnnnnn . nn | Minimum Eastings, (National Grid Coordinates) |
| 20 | |
| nnnnnnn . nn | Minimum Northings, (National Grid Coordinates) |
| 9 | |
| \$EXTMAX | X and Y drawing extents, upper right corner |
| 10 | |

| | |
|-----------------------------------|--|
| nnnnnnn . nn 20 | Maximum Eastings, (National Grid Coordinates) |
| nnnnnnn . nn 9 | Maximum Northings, (National Grid Coordinates) |
| \$LIMMIN 10 | X and Y drawing limits, lower left corner |
| nnnnnn . n 20 | X drawing limit, lower left corner, (in the AutoCAD World Coordinate System) |
| nnnnnn . n 9 | Y drawing limit, lower left corner, (in WCS) |
| \$LIMMAX 10 | X and Y drawing limits, upper right corner |
| nnnnnn . n 20 | X drawing limit, upper right corner, (in WCS) |
| nnnnnn . n 9 | Y drawing limit, upper right corner, (in WCS) |
| \$LTSCALE 40 100.0 9 | Global Linetype scale |
| \$ATTMODE 70 1 9 | Attribute visibility This sets attributes to 'on' when the file is open |
| \$FILLMODE 70 1 9 | Fillmode 'on' if non-zero |
| \$TEXTSIZE 40 1.0 9 | Default text height |
| \$TEXTSTYLE 7 STANDARD 9 | Current text style name |
| \$CELTYPE 6 BYLAYER 9 | Entity Linetype name |
| \$CECOLOR | Entity colour name |

| | | |
|------------|--|--|
| 62 | | |
| 256 | Indicates colour id BY LAYER | |
| 9 | | |
| \$LUNITS | Units format for coordinates and distances | |
| 70 | | |
| 2 | | |
| 9 | | |
| \$LUPREC | Units precision for coordinates and distances | |
| 70 | | |
| 1 | | |
| 9 | | |
| \$AUPREC | Units precision for angles | |
| 70 | | |
| 1 | | |
| 9 | | |
| \$ANGBASE | Angle zero direction | |
| 50 | | |
| 0.0 | | |
| 9 | | |
| \$ANGDIR | Angle rotation | |
| 70 | | |
| 0 | 1 = clockwise angles, 0 = anti-clockwise angles | |
| 9 | | |
| \$PDMODE | point display mode | |
| 70 | | |
| 1 | | |
| 9 | | |
| \$PDSIZE | Point display size | |
| 40 | | |
| 0.0 | | |
| 9 | | |
| \$PLINEGEN | Sets the linetype pattern generation around the vertices of a 2-dimensional Polyline | |
| 70 | | |
| 1 | | |
| 0 | | |
| ENDSEC | End of Section | |

Tables

Figure B.3: Level 2

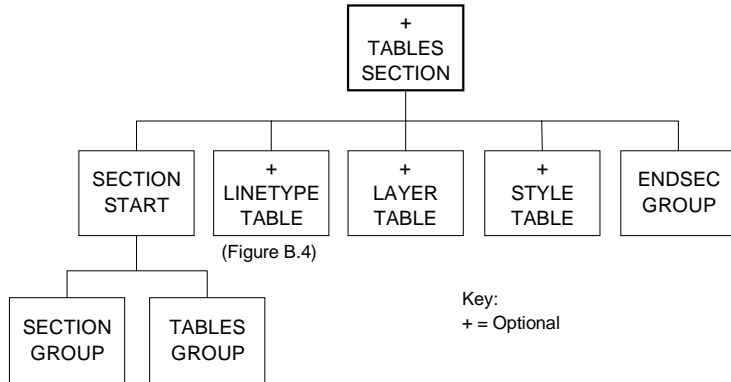

The Tables Section will follow the Header Section and will contain three tables:

- Linetype Table
- Layer Table
- Style Table.

Figure B.4: Linetype Table Level 3

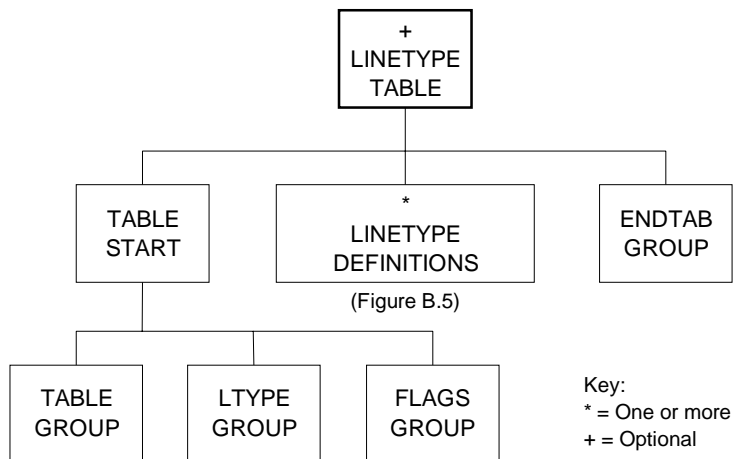

The Linetype Table will contain definitions for the following line types:

- solid line (CONTINUOUS)
- dashed line (DASHED)
- dashdot line (DASHDOT)
- dotted line (DOT).

Figure B.5: Level 4

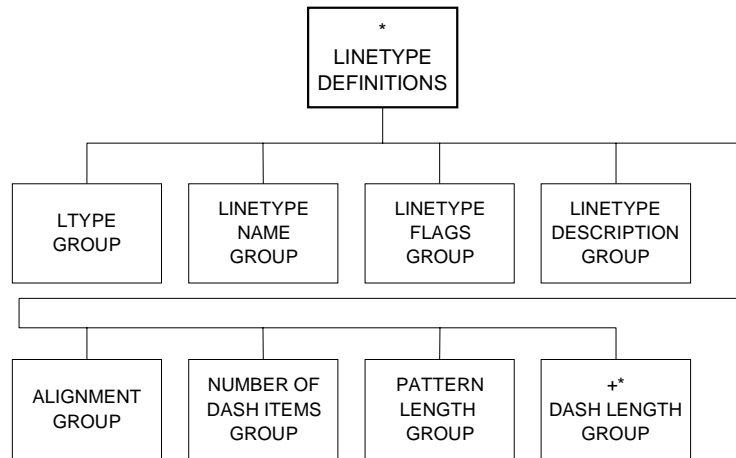

Key:
 * = One or more
 + = Optional

Thus :

```

0
TABLE
2
LTYPE
70
5
0
LTYPE
2
CONTINUOUS
70
64
3
    
```

Solid Line

72
65
73
0
40
0.0
0

LTYPE

2

DASHED

70
64
3

72
65
73
2

40
0.75
49
0.5
49
-0.25
0

LTYPE

2

DASHDOT

70
0
3

.....
72
65
73
4

40
1.0
49
0.5
49
-0.25
49

```
0.0
49
-0.25
0
LTYPE
2
DOT
70
    64
3
.....
72
    65
73
    2
40
0.25
49
0.0
49
-0.25

0
ENDTAB
```

Figure B.6: Level 3

Details of the Layer table can be seen in Appendix A.

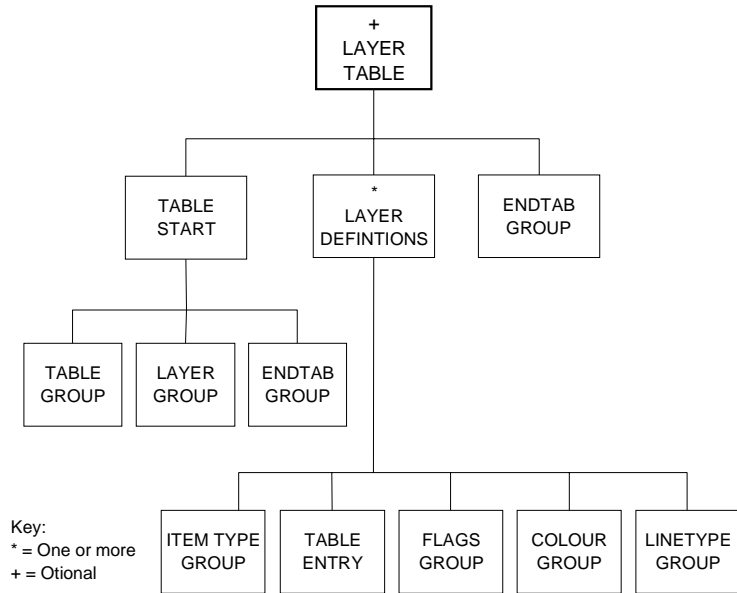
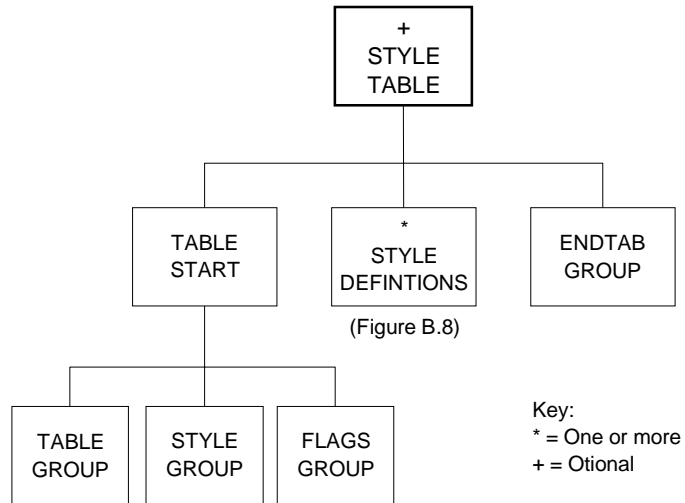

Figure B.7: Style Table level 3



The Style Table will contain the text file load instructions for:

- SIMPLEX.SHX
- MONOTEXT.SHX.

Figure B.8: Level 4

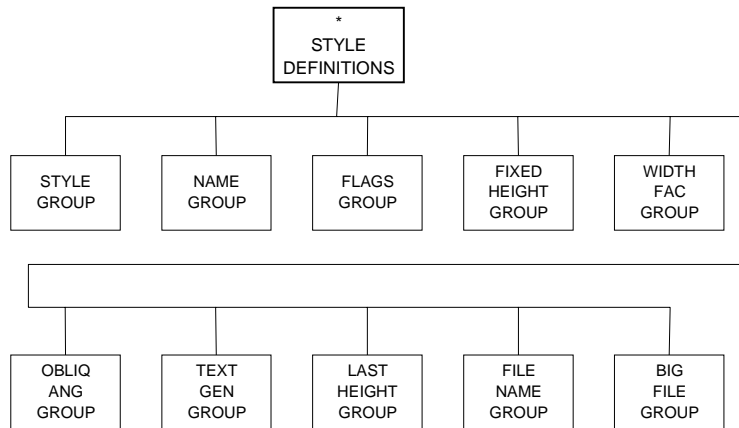

Blocks

Figure B.9: Level 2

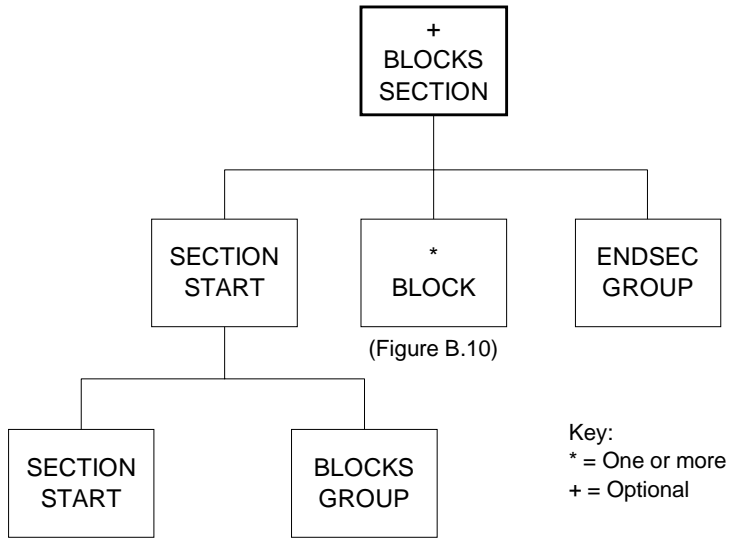
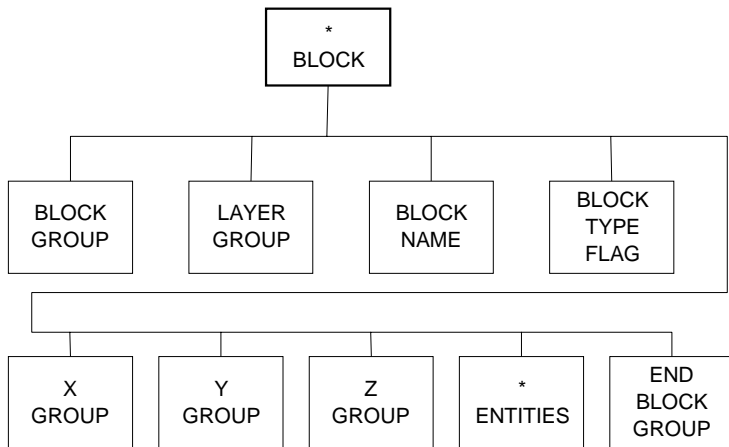

Figure B.10: Level 3



Entities Section

The Entities Section will contain DXF entities for:

- OS map footnotes data (INSERT entities);
- Grid and neatline (TEXT and LINE entities); and
- OS features (TEXT, POLYLINE and INSERT entities)
- Extended Entity Data will be used to store attributes.

The structure of each different entity is as follows:

a. INSERT entities - these consist of:

- INSERT entity type group (Attribute number 0)
- Layer name group (8)
- Block name group (2)
- X coordinate group (10)
- Y coordinate group (20)
- X scale factor (41) [optional]
- Y scale factor (42) [optional]
- Orientation group (50) [optional if 0].

b. LINE entities - these consist of:

- LINE entity type group (0)
- Layer name group (8)
- Start X coordinate group (10)
- Start Y coordinate group (20)
- End X coordinate group (11)
- End Y coordinate group (21).

c. POLYLINE entities - these consist of:

- POLYLINE entity type group (0)
- Layer name group (8)
- Vertices follow flag group (66)
- Polyline flags group (70) [optional]
- A number of VERTEX entities [shown on the next page]
- SEQEND group (0).

d. VERTEX entities - these consist of:

- VERTEX entity type group (0)
- Layer name group (8)
- X coordinate group (10)
- Y coordinate group (20)
- Z coordinate group (30).

e. TEXT entities - these consist of:

- TEXT entity type group (0)
- Layer name group (8)
- X coordinate group (10)
- Y coordinate group (20)
- Text height group (40)
- Text string group (1)
- Justify type group (72) [optional if 0]
- Justify type group (73) [optional if 0]
- Orientation group (50) [optional if 0]
- Text style group (7) [optional]
- Align X group (11) [only present if Justify type group is present and has a value of 2]
- Align Y group (21) [only present if Justify type group is present and has a value of 2].

f. EXTENDED entities - these consist of:

- Application name (1001)
- Control string (1002)
- String (1000) [one or more]
- Control string (1002).

Figure B.11: Level 2

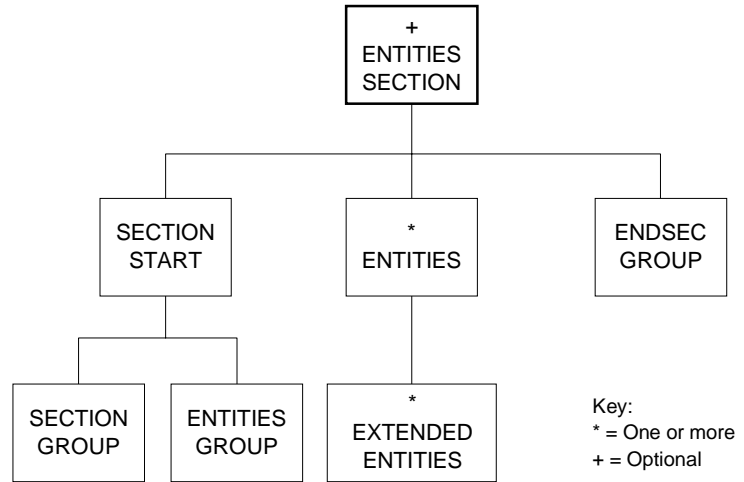

Figure B.12: Level 3

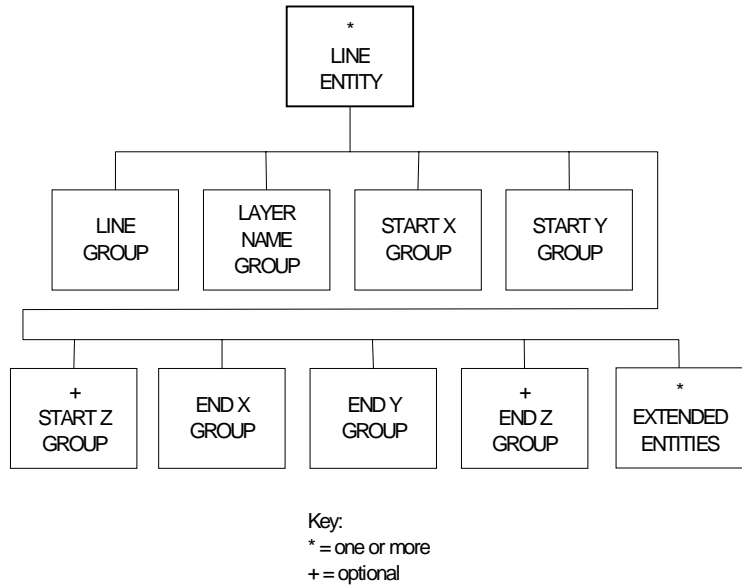

Figure B.13: Level 3

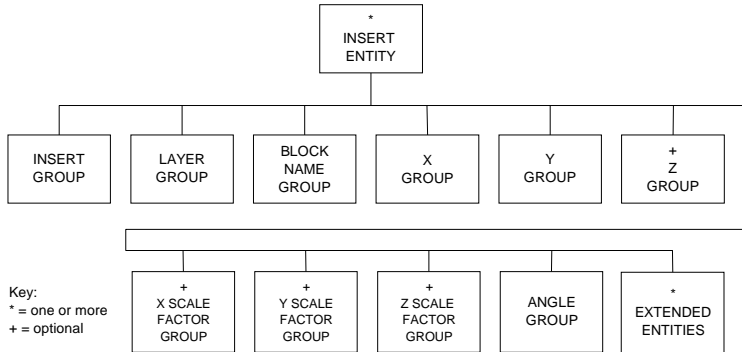

Figure B.14: Level 3

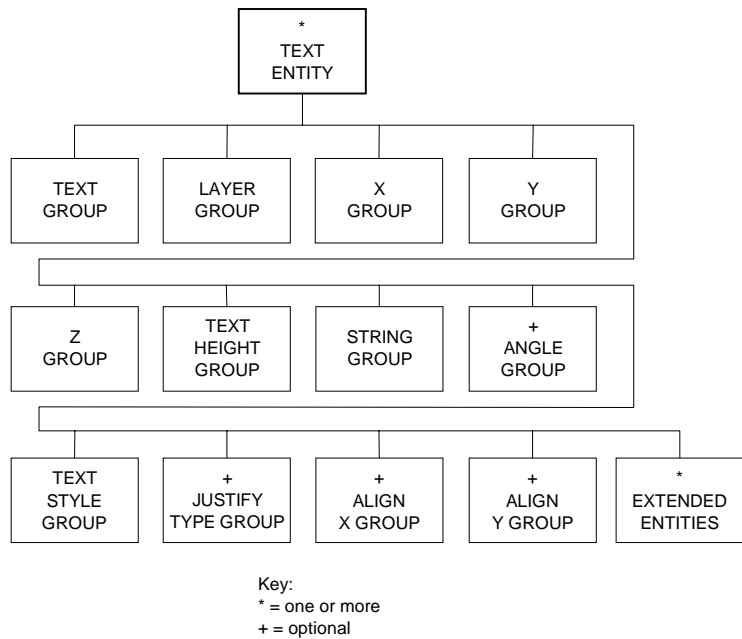
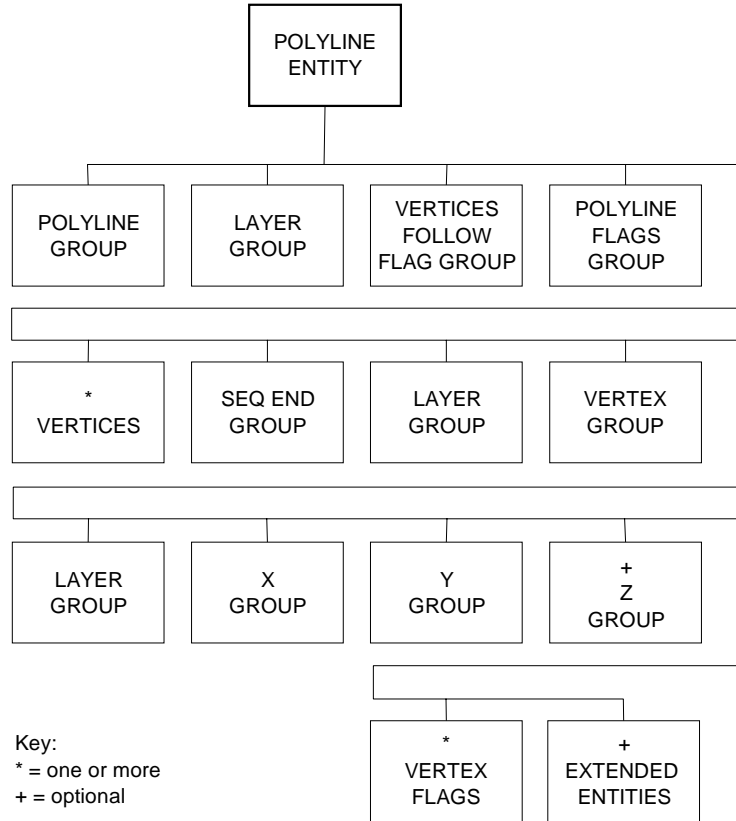

Figure B.15: Level 3



End of File Group

This group will end with DXF EOF, (End Of File) group.

