



[www.ordnancesurvey.co.uk](http://www.ordnancesurvey.co.uk)

# Meridian<sup>TM</sup> 2

User guide v3.0



## Preface

This user guide contains all the information you need to make effective use of Meridian™ 2. It is designed to help you understand the information contained in the data, as well as providing detailed technical information and the data format specification.

This user guide has been checked and validated before issue and every endeavour made to ensure that the contents are accurate. If you find an error or omission, or otherwise wish to make a suggestion as to how this user guide can be improved, please contact us at the address shown under **Contact details**.

The contents of this user guide will be updated by the release of replacement chapters.

## Contact details

Sales Information will be pleased to deal with your enquiries:

### **Sales Information Helpdesk**

Phone: 08456 05 05 05

Fax: 023 8079 22615

Email: [enquiries@ordsvy.gov.uk](mailto:enquiries@ordsvy.gov.uk)

or write to:

Sales Information  
Ordnance Survey  
Romsey Road  
SOUTHAMPTON  
United Kingdom  
SO16 4GU

Visit the Ordnance Survey web site at: [www.ordnancesurvey.co.uk](http://www.ordnancesurvey.co.uk)

## Product performance

If you have any problems with or identify any errors in the data, or this user guide, please complete the [Product performance report form](#) at appendix B and return it to us.

## Liability

A full description of the terms and conditions of supply and use of Meridian 2 is detailed in the signed *Customer contract* held by you or your organisation.

Ordnance Survey makes every effort to ensure that data supplied is free from errors and omissions. We will remedy, as soon as reasonably practicable, errors and omissions that the customer notifies to us in writing. It is the customer's responsibility to ensure that data ordered is suitable for the intended purpose. We will not be liable to the customer or any other party for any loss, damage, inconvenience or expense resulting from the use of, or reliance upon, the data.

## Delivery of Meridian 2

You are advised to copy the supplied data to a back-up medium.

Written notification of any deficiency in the data or damage to the goods must be given to us within 28 days of receipt of your Meridian 2 data.

## Data copyright

All Ordnance Survey digital map data are Crown copyright. Full details of the conditions under which our digital map data may be processed and/or manipulated or copied by a customer – whether or not for use on PCs or workstations or for making hard copies – are contained in Ordnance Survey leaflet: *Copyright 1 – Business use of our digital and conventional mapping*. This is available from Copyright Licensing at the address on the previous page. You should check the terms and conditions with us before using the data. It is also the responsibility of the holder of the digital map data to ensure that any plotted or printed output contains the required copyright acknowledgement.

## User guide copyright

This document is © Crown copyright 2000. All rights reserved. It is supplied with Meridian 2 to allow you to make effective use of the data. Any part of it may be copied for your own business use. Business use is defined as actions related to business decision-making or as part of day-to-day operations associated with the running of a business. No part of this document may be copied or incorporated in products, services or publications you generate for onward sale or as free promotional or support material without the prior written permission of Ordnance Survey.

## Trademarks

Ordnance Survey, the OS Symbol, Land-Form PANORAMA, Land-Line, Landranger, OSCAR, OSCAR Asset-Manager, OSCAR Route-Manager and Strategi are registered trademarks and Boundary-Line and Meridian are trademarks of Ordnance Survey, the national mapping agency of Great Britain.

AutoCAD and Autodesk are registered trademarks and DXF is a trademark of Autodesk Inc.

Helvetica is a registered trademark of Linotype AG and/or its subsidiaries.

Univers is a registered trademark of Haas'sche Schriffigiesserei.



# Contents

Chapter 1	Introduction	1.1
	Meridian 2 features	1.2
	Applications of Meridian 2	1.2
	What you need to use Meridian 2	1.4
	Computer hardware	1.4
	Computer software	1.4
	Supply	1.5
	Meridian 2 supply options	1.5
	Meridian 2 supply formats	1.5
	Meridian 2 supply media	1.5
Chapter 2	Overview of Meridian	2.1
	Data overview	2.1
	Basic principles	2.1
	Meridian 2 vector data structure	2.2

Chapter 3	Meridian explained	3.1
	Features	3.1
	Points and lines	3.2
	Feature position	3.5
	Feature attribute data	3.6
	Feature codes	3.6
	Names as attributes	3.8
	Road number (RN) attribute	3.8
	Trunk road (TR) attribute	3.8
	Line length (LL) attribute	3.8
	Number of parents (NP) attribute	3.9
	OSODR attribute	3.9
	Link level at node	3.11
	Proper name (PN) attribute	3.11
	Parent OSODR (PO) attribute	3.12
	Roundabout (RT) attribute	3.12
	Junction name (JN) attribute	3.12
	Settlement name (SN) attribute	3.12
	Unique identifiers	3.13
	Feature layer descriptions	3.15
	1 Roads	3.15
	2 Railways	3.15
	3 Administrative areas and coastline	3.16
	4 Developed land use areas	3.17
	5 Cartographic names	3.18
	6 Hydrology	3.20
	7 Woodlands	3.21
	8 Gridded height	3.21



Chapter 4	Quality statement	4.1
	Source of Meridian 2	4.1
	Currency	4.2
	Accuracy and resolution	4.2
	Completeness	4.3
	Meridian general specifications	4.3
Chapter 5	The National Grid	5.1
Chapter 6	NTF explained	6.1
	An overview of Meridian 2 in NTF	6.1
	Jackson structure	6.3
	Transfer set structure	6.6
	Supply of data on formatted media	6.7
	Version management	6.10
	General	6.10
	Section body	6.11
	Point and line features	6.11
	Name detail	6.12
	Node detail	6.13
	Feature information relevant to NTF	6.14
	Point features	6.14
	Line features	6.14
	Coordinates	6.14
	Bearings	6.15
	Attribute codes	6.15
	Unique identifiers	6.17
	Record IDs	6.17
	Feature layers	6.19

<b>Chapter 7</b>	<b>Record structures for the transfer of Meridian 2 in NTF</b>	<b>7.1</b>
	NTF Record List	7.1
	Volume Header Record [VOLHDREC] 01	7.2
	Database Header Record [DBHREC] 02	7.3
	Feature Classification Record [FEATCLASS] 05	7.5
	Section Header Record [SECHREC] 07	7.6
	Attribute Record [ATTREC] 14 for road links	7.8
	Attribute Record [ATTREC] 14 for road nodes	7.10
	Attribute Record [ATTREC] 14 for administrative area links (county, district, coastline and neat line)	7.12
	Attribute Record [ATTREC] 14 for administrative area points and/or seeds	7.13
	Attribute Record [ATTREC] 14 for nodes (administrative areas, developed land use area, coastline and railway, hydrology and woodlands) and/or edge nodes (all layers)	7.14
	Attribute Record [ATTREC] 14 for developed land use area links	7.14
	Attribute Record [ATTREC] 14 for developed land use area points and/or seeds	7.15
	Attribute Record [ATTREC] 14 for cartographic name text	7.16
	Attribute Record [ATTREC] 14 for railway links	7.17
	Attribute Record [ATTREC] 14 for railway station nodes	7.18
	Attribute Record [ATTREC] 14 for water feature (river, small)	7.19
	Attribute Record [ATTREC] 14 for water area seeds	7.20
	Attribute Record [ATTREC] 14 for administrative area points and/or seeds	7.21
	Attribute Record [ATTREC] 14 for gridded height point	7.22
	Point Feature Record [POINTREC] 15	7.23
	Node Record [NODEREC] 16	7.24
	Two-dimensional Geometry Record [GEOMETRY1] 21 associated with POINTREC	7.25
	Two-dimensional Geometry Record [GEOMETRY1] 21 associated with LINEREC	7.26
	Line Feature Record [LINEREC] 23	7.27
	Attribute Description Record [ATTDESC] 40	7.28
	Text Record [TEXTREC] 43	7.29
	Text Position Record [TEXTPOS] 44	7.30
	Text Representation Record [TEXTREP] 45	7.31
	Comment Record [COMMENT] 90	7.32
	Volume Terminator Record [VOLTERM] 99	7.33

Chapter 8	DXF explained	8.1
	An overview of Meridian 2 in DXF	8.2
	DXF	8.2
	Structure of Meridian 2 in DXF	8.3
	Line features	8.3
	Area features	8.3
	Name features	8.3
	Drawing content and format	8.4
	Coordinate system	8.4
	Height	8.4
	Layer names	8.4
	Neatline	8.5
	Grid	8.5
	Grid values	8.5
	Meridian 2 DXF layers	8.6
	DXF footnotes	8.8
Chapter 9	DXF file structure for Meridian 2	9.1
	General	9.1
	Data structure	9.2
	Header	9.3
	Tables	9.7
	Blocks	9.16
	Entities Section	9.18
	End of File Group	9.25
Appendix A	Glossary	A.1
Appendix B	Product performance report form	B.1



# Chapter 1 Introduction

This user guide is designed to enable users to make effective use of Meridian 2, and contains all the information you will need.

This chapter and [chapter 2](#) provide an introduction to Meridian 2 and illustrate potential applications. [Chapter 3](#) contains details of the components of the data. Please refer to the [Glossary](#) if you are unfamiliar with the terms used.

All aspects of Meridian 2 discussed in this user guide relate to Meridian 2 in both BS 7567 (NTF v2.0) and DXF™ (AutoCAD® Release 12) formats. If the two format versions differ in their treatment of a particular aspect, the specific differences will be stated. Icons, as shown below, will be used to denote these differences.



For convenience BS 7567 (NTF v2.0 level 3) is referred to as NTF in this user guide.



Data Exchange Format (DXF) is referred to as DXF in this user guide.

Format information on the Meridian 2 data is contained in [chapters 3 and 8](#).

Ordnance Survey's Meridian 2 provides a comprehensive national database of geographic (spatial) information designed to support a wide range of applications including initial planning and project work at a regional level. Concepts of Meridian 2 are explained fully in [chapter 2](#).

Appropriate software is required to facilitate the customer's intended application.

The database has been derived from Ordnance Survey's existing large and small scales digital databases.

## Meridian 2 features

- Meridian 2 has feature codes which allow everything in the database to be allocated to a specific category; users can group like-features for search, display and output routines.
- Meridian 2 is defined as a limited *link and node* structure within each layer. It contains points, lines and nodes. Nodes have pointers to lines that join at the node and, similarly, there are lines that enclose an area containing a point. Some points are not contained within areas enclosed by lines.
- Department of Environment, Transport and the Regions (DETR) road classification numbers are stored in attribute records and are applied to features such as roads. Names applying to administrative areas and developed land use areas are also included in the attribute record of the appropriate point feature
- Annual updating of source databases ensures that high standards of currency and integrity are maintained.

## Applications of Meridian 2

There are many potential applications for Meridian 2. These include:

- Environmental analysis:
  - flood areas analysis.
- Land management.
- Commercial and/or business site development.
- Routing analysis.
- Retail and/or wholesale trades.
- Distribution networks:
  - store and/or warehouse locations; and
  - strategic business expansion and/or development.

- Marketing and media planning:
  - sales force locations and/or territories;
  - sales prospecting;
  - market analysis of customers, competitors or outlet densities;
  - market analysis of direct mail responses;
  - poster distribution;
  - TV and/or radio advertising regions; and
  - product and/or brand promotion campaigns.
- Financial/Insurance:
  - customer bases; and
  - high/low risk areas.
- Health:
  - community health; and
  - health black spots.
- Leisure activities
  - large site planning, for example, golf courses;
  - tourism; and
  - theme park locations.

## What you need to use Meridian 2

### Computer hardware

Providing that sufficient memory and storage facilities are available, there are no constraints on hardware platforms which can be used. The range of hardware which can typically be used varies from higher specification personal computers (PCs), using GIS (geographic information systems) or CAD (computer-aided design), to mainframe computers with specialised translators and applications.

### Computer software

Meridian 2 is supplied as inert data and does not include software for data manipulation. To exploit fully the potential of Meridian 2 it is necessary to use appropriate application software such as GIS or CAD.



NTF format allows users of GIS to customise their own definition of the data and/or plotting for their specific applications. The parameters defining colours, line styles, text styles, symbols and so on should be built into user software. Symbol definitions used by Ordnance Survey are given in [chapter 3](#). Meridian 2 may be customised by viewing or plotting features in different colours, line styles and scales to suit different applications. Certain classes of features may be omitted from customised plans on the basis of selection by feature code.



DXF transfer format is designed for use with Autodesk Ltd CAD software particularly AutoCAD. The parameters defining colours, line styles, text styles, symbols and so on are embedded within the DXF file, as is customary with this CAD format.

**Please check with your supplier if you are unsure of your CAD system's compatibility with Meridian 2.**



# Supply

## Meridian 2 supply options

The options for data supply are as follows:

- Complete national cover of Great Britain (2857 tiles);
- England;
- Scotland;
- Wales;

(These areas correspond with Nomenclature des Unites Territoriales Statistique (NUTS) Level 1 Areas.)

- 10 km by 10 km tiles.

## Meridian 2 supply formats

Meridian 2 is available in:

- NTF BS 7567 v2.0 Level 3; or
- DXF (conforming to AutoCAD release 12 with extended entity data).

## Meridian 2 supply media

NTF is supplied on CD-ROM only.

DXF is supplied on CD-ROM only.



### Data overview

#### Basic principles

Links represent roads, railways, administrative areas, coastline, developed land use area, Inland water and woodland area lines.

Nodes represent all intersections of links within each layer, changes in attributes in links and link ends.

Each feature has associated geometry; this may be a single coordinate pair for a single point feature for a railway station, or two or more coordinate pairs for a linear feature.

Each feature is classified by means of a feature code.

Roads, railways, railway stations, administrative area seed points, developed land use area seed points, inland water and woodland area seed points have unique identifiers.

## Meridian 2 vector data structure

Meridian 2 data within each layer is supplied as vector data, in a link and node structure. Geographical features are represented as data entities either as points or lines. Points are fixed positionally by one coordinate pair, for example, a railway station. Lines are fixed positionally by a series of connected coordinate points to represent linear map features such as roads, railways and so on. Points and lines within the data model determine the **geometric** (positional) characteristics of the data.

Points and lines within the data model also have associated attributes. These give the point and line entities meaning, that is, they represent the descriptive characteristic of an entity such as a feature code, a name or numerical value. Lines are also added as closing links (neat lines) along tile edges; these are required to complete the enclosure of an area. The closing link has a different feature code to the other links enclosing the area.

Throughout Meridian 2 no line feature crosses from one tile to the next, but a point feature created at the tile edge has the same coordinate value as its partner on the adjacent tile.



All features having the same feature code are recorded on the same layer. DXF has a limited *link and node* structure; within this structure, a feature may be a name, point, or line. Each feature is freestanding, that is, its topological relationship to any other feature is not expressed in the data.

Other important data structure concepts include **networks** and **polygons**.

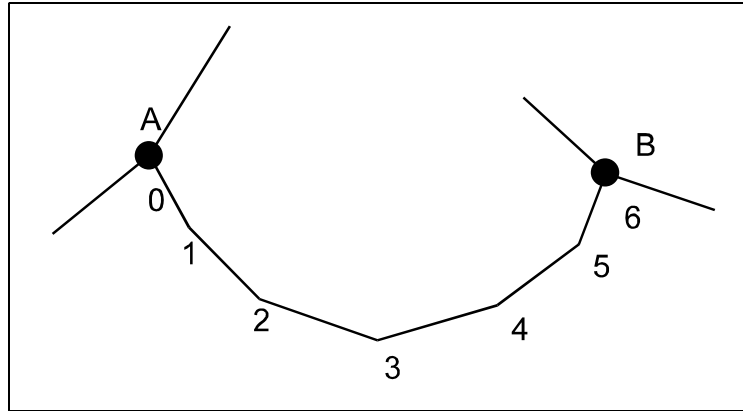
**Networks** are interconnecting features structurally related by means of an explicit point described as a **node**. Between the nodes are series of non-intersecting line segments described as **links**; hence link and node – see figure 2.1. This is of special interest in GIS where there may be a need to analyse the network in order to follow routes or to close polygons.

Proprietary GIS software can be used to build and maintain networks for linear features such as roads, railways and so on, and provides the functionality to store, manage and manipulate this data.

The properties of Meridian 2 make it a suitable basis for users wishing to develop applications using Meridian 2 together with their own data. As Meridian 2 is based on the National Grid, there is a simple way of overlaying users' own data provided the position is given within the National Grid.

The National Grid as it applies to Meridian 2 is explained in [chapter 5](#).

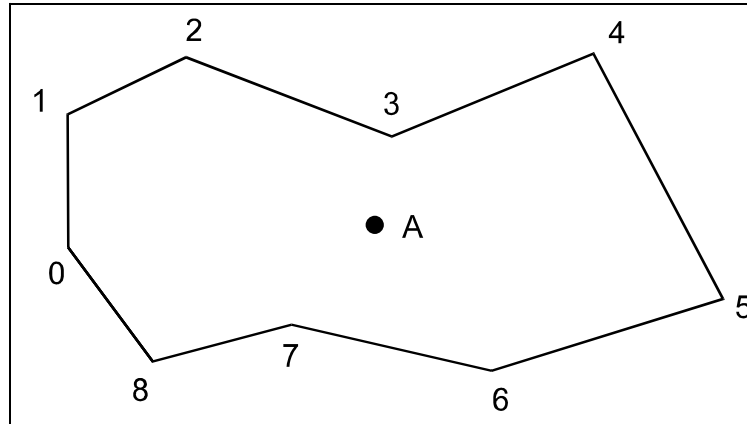
**Figure 2.1:** Link and node



*Points A and B are nodes, as they intersect with other features. The line A–B is the link, and, in this example, is made up of six individual line segments.*

**Polygons** are continuous areas defined by sets of bounding closed lines. These are implicit within the data, but can be explicitly created with appropriate software. Stored within recognisable polygons are **seed points**, which hold information about that polygon, for example, a county name.

**Figure 2.2:** Polygon



*Point A is the polygon seed point for the area: attached to this point are attributes such as the feature code, which defines the polygon and its definitive name. These attributes may be transferred to the polygon itself. The polygon in this example comprises nine individual line segments.*

There are also free-standing points, which are not associated with a defining polygon, for example, Liverpool Lime Street Station.

### Features

Meridian 2 has two feature classes:

- Point features.
- Line features.

Point features such as administrative area seed points and line features such as roads, railways, and developed land use areas are arranged into recognisable categories. A full listing of individual features is given in [chapter 6](#).

Each feature has two components:

- Feature position.
- Feature attribute data.

Also explained in this chapter:

- Feature layer descriptions.



Each feature recorded in Meridian 2 should be considered as a DXF entity. Line features are recorded as DXF Line(s) or Polyline(s).

Point features will be recorded in the data as INSERT BLOCKS. Certain standard symbols are defined in the BLOCKS section of the data file. A list of these standard symbols is shown in [chapter 8](#). Attributes are stored as extended entity data.

## Points and lines

Real-world geographic features are represented in the digital map data as structures of lines and points. Each point or line has a geometric and attribute component.

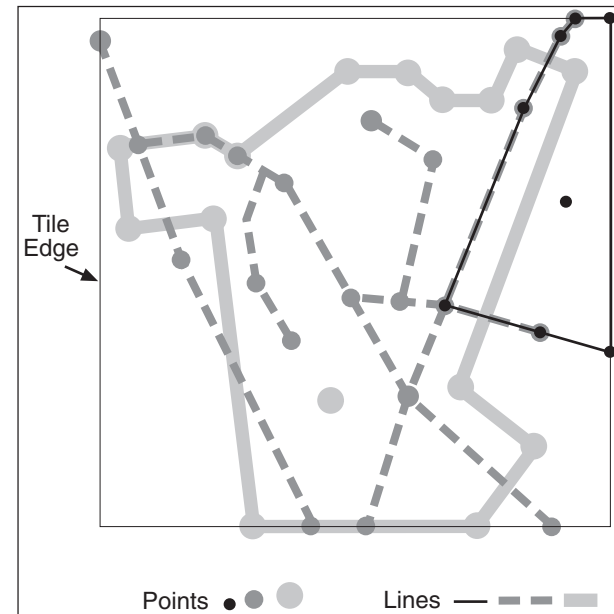
The geometric component defines the positional characteristic of the feature, and implicit relationships exist between points and lines based on relative position. The attribute component defines the descriptive characteristics of the feature.

Points may exist independently of lines.

A diagrammatic example of a geometric structure is shown in figure 3.1a.

**Figure 3.1a:** A geometric structure of points and lines.

Solid black, grey and broken grey lines and associated points are on different layers.





Points and lines from the geometric structure become features when an attribute, the feature code, has been added, for example, developed land use area seed points are created from points, or developed land use area boundaries from lines.

**Figure 3.1b:** The same geometric structure as features

Solid black, greys, and broken grey are on different layers.

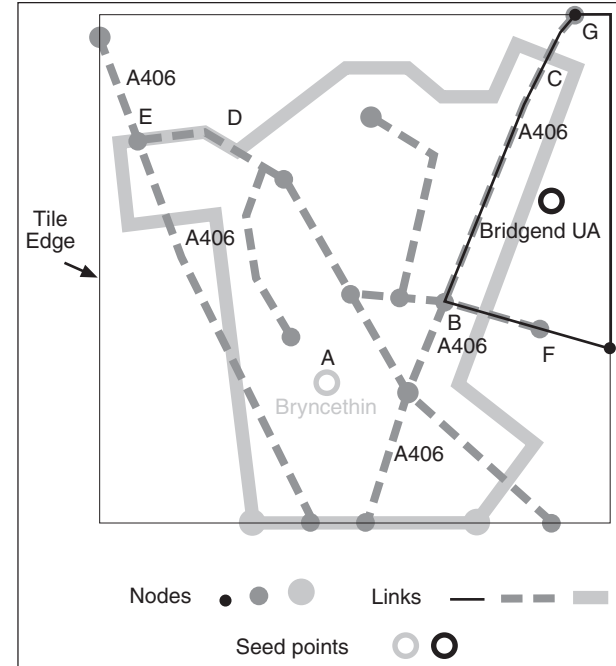
In figure 3.1b:

**Point A** is a seed point with a feature code that identifies it as a developed land use area; the seed point also carries its name attribute – Bryncethin.

**Point B** is a coordinate junction between intersecting features – in this case, where a minor road intersects with the A4061. This is an example of a node.

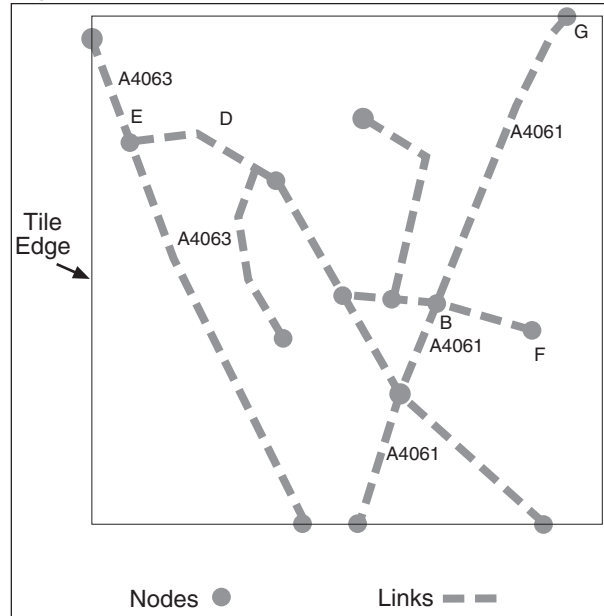
**Point C** is a position where the A4061 in one layer crosses the developed land use area boundary in another layer. There is no node at this point.

Some points and lines are common to more than one feature, as in figure 3.1b. Features between D–E and G–B–F are overlapping features and are stored separately within each layer of data.

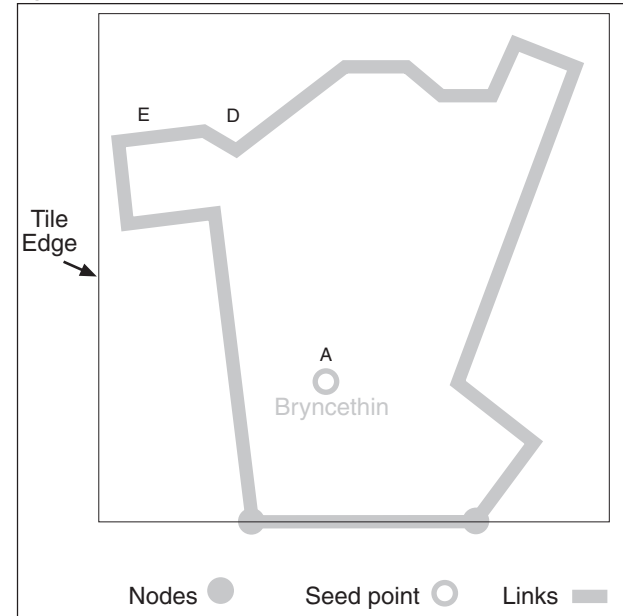


**Separate storage of overlapping features**

**Figure 3.1c: Roads**

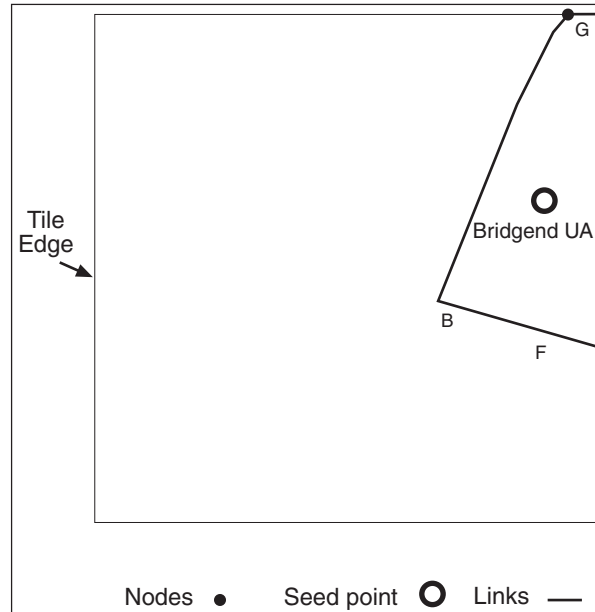


**Figure 3.1d: Developed land use area**



In figures 3.1c and 3.1d line D–E is common to the minor road and the developed land use area boundary and the geometry of each feature is stored separately.

**Figure 3.1e:** Administrative areas and coastline



In figures 3.1c and 3.1e line G–B–F is common to the A4061, the minor road and administrative area boundary and the geometry of each feature is stored separately.

## Feature position

The geometry of map features is defined in terms of coordinates. All coordinates used in Meridian 2 are based on the National Grid coordinate referencing system, and are quoted to a resolution of 1 metre.

The National grid, as it applies to Meridian 2, is explained more fully in [chapter 5](#).

## Feature attribute data

An attribute is the descriptive characteristic of a feature, that is, a non-spatial element.

The geometry of the points and lines within the data would be meaningless to the user unless they are assigned some distinguishing property. In Ordnance Survey map data terms, an attribute can be a feature code (in NTF these are numeric codes), for example, 3000, or a distinctive name or number, for example, Birmingham or M40.

Attribute codes relevant to NTF are listed and described within [chapter 6](#), but an overview is given below.

## Feature codes

Each feature is classified by means of a feature code (FC). A feature code is allocated when each feature is initially interpreted and captured from the map base. In this way, an A road is distinguished from a B road and other kinds of line feature by the feature code allocated to it.



Each feature is classified as belonging to a specific feature code. These feature codes are listed in [chapter 6](#).



Each feature is classified as belonging to a specific feature layer. These layers range in value from G8050570 to G8056801; see the AutoCAD publication *Layer Naming Convention for CAD in the Construction Industry*, version 2, based upon guidelines in BS 1192: Part 5 – *Guide for structuring of computer graphic information*. These feature layers are listed in [chapter 8](#). Attributes are stored as extended entity data.

A further four text feature codes for layout of footnotes are included. These feature codes are listed in [chapter 8](#).

In order to display the attributes stored as extended entity data, the following two scripts are required. These two files, 'Showeed.lsp' and ' Showeed.dcl', are contained in the 'EXE' directory on the Ordnance Survey-supplied CD-ROM and should be placed in a directory in the AutoCAD preferences search string. This should include the directory containing the map data files in DXF.

To utilise the scripts, type the following at the AutoCAD command line prompt within a drawing session:

```
AutoCAD: (load "showeed")  
AutoCAD: eedd
```

Selecting a map feature will now display the allied attributes of that feature in a dialogue box. To interrogate other features, the Re-Select option on the user dialogue box should be chosen. The Cancel option will return the user to a normal AutoCAD session.

If the `eedd` command is repeated at the command prompt, the facility will again be available to the user.

The visibility of extended entity data to software other than AutoCAD Release 12 will be constrained by the functionality of those individual software applications.

These differences in the data are inferred during translation from Ordnance Survey's internal data format to the required customer transfer format.

## Names as attributes

The criteria for names attribute attachment are:

- **Admin name (NM)** is an attribute of a seed point in its administrative area, for example, Hampshire County.
- **Proper name (PN)** is an attribute of a seed point in a developed land use area, for example, Bexhill, or a node point for a railway station, for example, Great Ayton Station.
- **Text (TX)** is a text string transferred in an attribute record to be displayed as stand-alone cartographic text, for example, Southampton – a place name.
- **Hydrology (WA)** is an attribute of a seed point in a water area.
- **Woodlands (FA)** is an attribute of a seed point in a woodland area.

## Road number (RN) attribute

This attribute defines the DETR road classification number, for example, M40 which relates to a **link**. If a road is not classified then this attribute will not be present.

## Trunk road (TR) attribute

This attribute defines whether the **link** forms part of a trunk road. If it is then the link will have a trunk road attribute with a value of Y and if it is not a trunk road then there will be no value in this field.

## Line length (LL) attribute

This attribute defines the length of the link in metres and will be present for all **link** records. It is calculated from the planimetric coordinates making up the link and does not take into account the effect of slope. The link length in all products refers to the length as recorded in the OSCAR® database.

## Number of parents (NP) attribute

Because the data in the Meridian 2 road layer is generalised, a feature may be derived from one or more basic OSCAR Asset-Manager® features. Thus there may be a number of parent OSODR (PO) attributes associated with a single feature. An additional attribute, number of parents (NP) OSODRs is therefore supplied, which defines the number of PO attributes that may be allocated to a feature. NP attribute is supplied primarily to act as a counter to the number of parent OSODR attributes that are supplied for a particular feature. PO and NP attributes apply to both **links** and **nodes** in the Meridian 2 road data.

In the Meridian 2 road data, all links at roundabouts and complex junctions will have been reduced to a single node point. Therefore, the parent OSODRs referenced as attributes of node records may refer to both nodes and links in OSCAR Asset-Manager.

## OSODR attribute

This attribute defines the Ordnance Survey ROADS Database Reference (OSODR). This will uniquely identify any link or node within the national OSCAR dataset. The OSODR will be used as the unique identifier for each link and node, rather than the NTF identifiers. The NTF identifiers will be unique within each tile that is supplied but will not be maintained between supplies.

A road object is part of a road between nodes (junctions) uninterrupted by tile or map edges.

An OSODR refers not just to a single link but may refer to many links that make up a road object – which may be chained together across tile edges. Thus, on adjoining tiles, there may be two or more links with the same OSODRs. This attribute applies to links and nodes. It will be present for all features.

An OSODR has been assigned to all existing features (links and nodes) in the OSCAR database. Any features, which are new to ROADS after the initial allocation, will be assigned an OSODR when they are loaded to the database.

The OSODR for a feature will never be modified – only created and deleted. However, there may be many changes to a feature with a specific OSODR during the lifetime of that OSODR allocation. There are two reasons for changes. These are:

- 1 the coordinates of the feature may move within a specified tolerance – currently 3 m either side of a link, 10% of its length, and 5 m movement of any node; or
- 2 the attributes associated with a feature may change. Any changes to these attributes will not affect the OSODR allocated to that feature.

The following attributes may change for **link** features:

- date of survey of conversion;
- feature code;
- length of link;
- road name;
- road number; and
- trunk road indicator.

The following attributes may change for **node** features:

- direction of links at node;
- feature code;
- junction name;
- number of links at node;
- level of link at node; and
- settlement name.

If a feature moves by more than the specified tolerance, then the OSODR for the feature will be deleted and a new OSODR allocated to that feature. If a feature is deleted from the OSCAR product and the ROADS database, then the OSODR allocated to that feature will cease to exist and will not be reallocated.



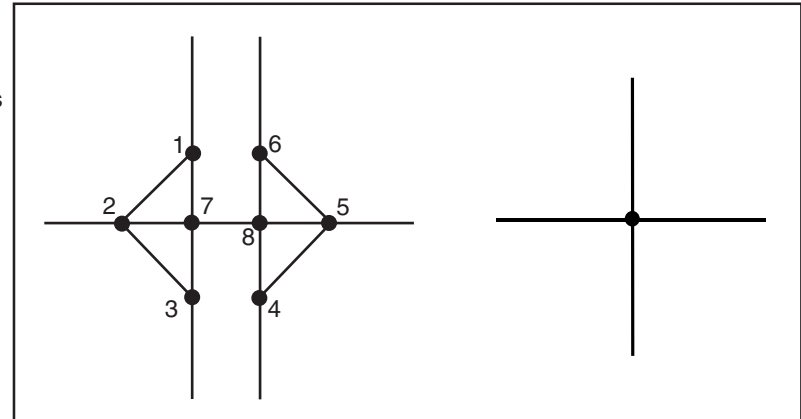
## Link level at node

The level field in [Node Record 16](#) indicates – for roads – the relative height relationship between intersecting links at a node. It does not relate to ground surface level. If a road over a bridge can be accessed then a level value of 0 is used; a value of 1 used when there is no access from one road to the other at an intersection. See figure 3.2.

**Figure 3.2:** Grade separation

In this instance, the single node will show a level 0 for all links in Node Record 16 as it is possible to access any carriageway from any approach road.

A bridge over a road that cannot be accessed will show a level value of 1.



## Proper name (PN) attribute

This attribute defines the road name associated with any link in the ROADS database. If a link does not have a proper name then the attribute will not be present. Where the road is otherwise not named and part of a named estate, the estate name will be allocated to the road.

## Parent OSODR (PO) attribute

This attribute identifies the OSODRs of those OSCAR Asset-Manager links which have been generalised to form a link, or node, in Meridian 2 road data. This allows the user of the dataset to integrate Meridian 2 road data with the OSCAR Asset-Manager dataset by providing pointers back to the original data.

## Roundabout (RT) attribute

This attribute defines whether a node is a generalised representation of a roundabout in the Meridian 2 road data. If it is, then the node will have a roundabout attribute with a value of Y.

## Junction name (JN) attribute

This attribute indicates the junction number of motorway junctions and the other classified roads at that junction. The junction name is variable length text, and is in the format M6J10A, where M6 is the DETR road number, and J10A indicates that this is the junction numbered 10A of the M6. If the junction has no junction number, then that part of the junction name is not supplied.

There could be any number of roads at a junction, therefore each classified road at that junction may be repeated in the junction name attribute. An oblique character (/) separates each road number and junction. The following is an example of a junction name attribute:

M40J1/A40/A413/A4020

This attribute only applies to **nodes**. If the node does not have a junction name, then this attribute is not present.

## Settlement name (SN) attribute

This attribute defines the name of a location or settlement. This name will be attached to the node, which is closest to the position of the location or settlement.

## Unique identifiers

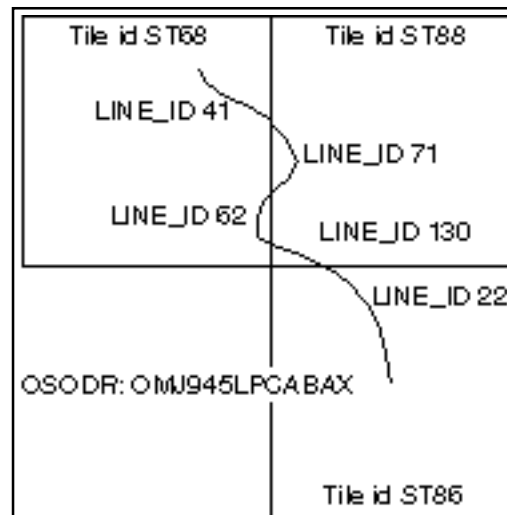
Unique identifiers are used to uniquely identify some features within Meridian 2. These are:

- **OSODR attribute** defines the Ordnance Survey ROADS Database Reference (OSODR). This will uniquely identify any link or node within the national OSCAR dataset.
- **Railway and railway station identifiers.** These uniquely identify any railway link or railway station within the national Meridian 2 database.
- **Developed land use area identifier.** This uniquely identifies any developed land use area seed point within the national Meridian 2 database.
- **Global identifier.** This uniquely identifies any administrative area seed point within the 10 km by 10 km tile.
- **Forestry identifier.** This identifies any forestry area seed point.
- **Hydrology identifier.** This identifies any hydrology area seed point.

The unique identifiers are unique references and will be maintained, except where there has been significant change to a feature.

The unique identifier may refer to several links representing a linear object across tiles, for example, a road or a railway, which may be chained together across tile edges. Thus, on adjoining tiles, there may be two or more links with the same unique identifier. [See figure 3.3.](#)

**Figure 3.3:** Unique identifiers



Unique identifiers have been assigned to all existing roads (links and nodes), railway links and railway stations and to seed points for administrative areas, developed land use areas, hydrology (inland water) and woodlands. Any of these features which are new to Meridian 2 after the initial allocation will be assigned an appropriate unique identifier when the database is refreshed.

The unique identifier for a feature will never be modified – only created and/or deleted. If a feature is deleted from the Meridian 2 database, then the unique identifier allocated to that feature will cease to exist.

# Feature layer descriptions

The feature codes, which appear in Meridian 2 within each layer, are detailed in [chapter 6](#). The individual layers, are described below.

**Note:** Names or numbers appear in all layers as attributes. The roads layer is the first hierarchical layer; the other layers will be manipulated to fit in the following 1–7 hierarchical order.

## 1 Roads

Motorways, major and minor roads are represented in the data. Complex junctions are collapsed to single nodes and multi-carriageways to single links. To avoid congestion some minor roads and cul-de-sacs less than 200 m are not represented in the minor road feature description of the data. Private roads and tracks are not included.

Hierarchical position 1.

## 2 Railways

All railway stations open to passengers and single-track passenger lines are represented.

A railway intersection consists of links and a node, but where railways cross at different levels, links are not broken. Links and nodes carry a feature code.

If the station name differs from the name of the built-up area on Ordnance Survey's large-scale data, for example, New Street Station in Birmingham, or if the railway station name is not associated to any built-up area name, for example, Great Ayton Station, then the points will carry a railway station name. Node attributes will also be shown as cartographic station names.

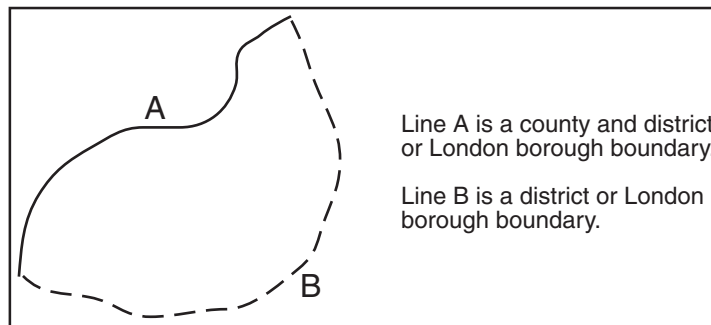
To maintain positional relationship, features in this layer may be adjusted and fitted to the roads.

Hierarchical position 2.

### 3 Administrative areas and coastline

Administrative areas include information for unitary authority areas for Scotland, Wales, county, district, and London borough boundaries for England.

**Figure 3.4:** Hierarchical relationship of boundaries for England



Each link for an administrative area carries a feature code and the administrative level associated with the left and right sides of that link. This also applies to coastline, but only to the landside of the coastline, that is, no administrative area information is added to the seaward side.

Each administrative area contains a seed point that identifies the enclosed area and carries a feature code and the associated administrative area name. Separate areas of the same administrative unit carry seed points with different identifiers.

Offshore islands carry a county and district or unitary authority seed point. There is no logical connection in the data between them and administrative units other than the same name attribute.

There is no explicit information to identify which links form the bounds of a particular area. The left and right county and district pointers on links do not contain the name of the administrative area, but refer to the seed point that has the administrative area name as its attribute.

The coastline follows the mean high water (MHW) up all estuaries to the normal tidal limit (NTL). Administrative areas are only shown down to MHW.

The administrative areas are adjusted to the coastline.

To maintain positional relationship, features in this layer may be adjusted and fitted to roads and railways.

Changes to the local authorities of Wales and Scotland that have taken place between 1 April 1998 and May 1999 have been incorporated in the Meridian 2 database.

Local government in England is still under review although some counties have been concluded. The operative dates for the new authorities extend from 1 April 1998 through to 1 May 1999.

Hierarchical position 3.

## 4 Developed land use areas

Developed land use area features include cities, towns, villages and industrial, commercial and business parks.

Link features enclose developed land use area features. Such areas contain a seed point that identifies the enclosed area and carry a feature code and the associated developed land use area name. **There is no explicit information to identify which link forms the bounds of a particular area.**

The whole developed land use area has been positioned to the road pattern by *best fit* practice.

Hierarchical position 4.

## 5 Cartographic names

Place names from the small-scales database and railway station attribute names are shown as independent text features and located near the feature that they describe.

Place names are collapsed from double-banked, treble-banked or composite text to a single text feature with all the text as one string.



The text font STANDARD and text height in metres have been used for these cartographic names and are as layers separate from the feature with which they are associated. These are the text font identifiers:

0001 has been used for railway text (Times Roman – non-italic)

0002 has been used for settlement text (Helvetica® bold – sans relief)

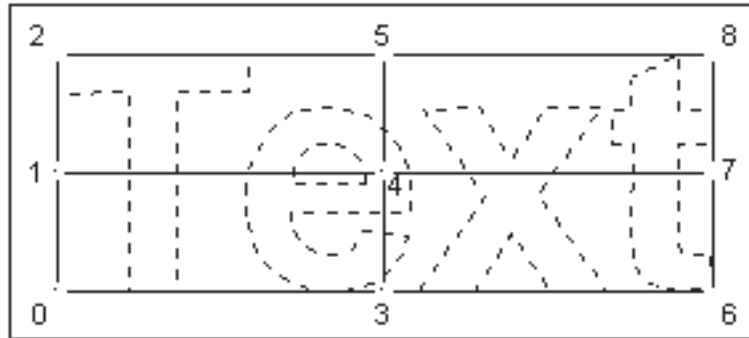
0003 has been used for water text (Times Roman italic – sans) these are transferred with the text feature

0004 has been used for town text (Univers® medium Roman condensed) and text height in millimetres.

The Ordnance Survey convention for the digitising of names is as follows: all names are digitised as point features, given as X and Y National Grid coordinates. The point has been digitised relative to the map feature it describes, and the actual point represents one of the standard positions shown in [figure 3.5](#).



**Figure 3.5:** Standard Ordnance Survey text positions



Names are normally placed on the printed map parallel to the horizontal grid.



Position 0 is supplied.



The text string may start, end or be centred on this coordinate pair; the relationship of the text to its coordinate pair is expressed as an *original digitised position*. Where the position of text features are recorded, one of these positions is digitised. Hierarchical position 5.

## 6 Hydrology

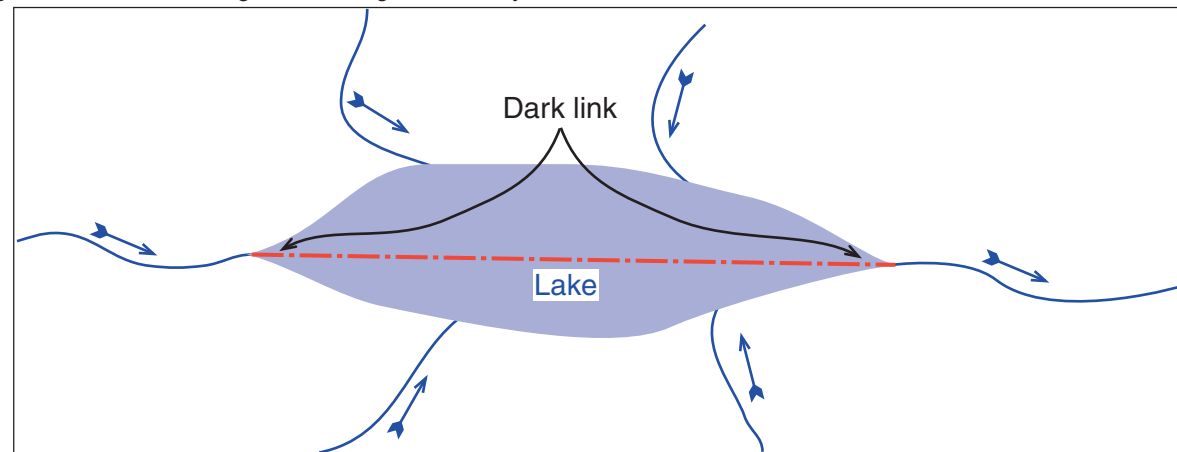
Each water area contains a seed point identifier, which carries a feature code and the associated attribute. Each link for water boundaries carries a feature code

To maintain positional relationship, features in this layer may be adjusted and fitted to the hierarchy. See the note at the beginning of [Feature layer descriptions on page 3.15](#).

Dark links have been used to maintain the connectivity of the network across lakes and reservoirs. Where links entering and leaving the lake or reservoir carry the same name, the dark link is attributed with this name.

Hierarchical position 6.

**Figure 3.6:** Dark link diagram showing connectivity



A river and tributaries flow into a lake. The amalgamation of these is a dark link running through the middle of the lake and outputting as a river again.

## 7 Woodlands

Each link for woodland boundaries carries a feature code. Each woodland area contains a seed point identifier, which carries a feature code and the associated attribute. To maintain positional relationship, features in this layer may be adjusted and fitted to hierarchy.

Hierarchical position 7.

## 8 Gridded height

Height information is produced in the form of a digital terrain model (DTM) style data.

Gridded height information is averaged from the 50 m resolution Land-Form PANORAMA® dataset to a resolution of 200 m and rounded down to the nearest 1 m value.



## Chapter 4 Quality statement

### Source of Meridian 2

Meridian 2 data are derived from large-scale and small-scale digital databases. The data capture source and scales are:

<b>Feature</b>	<b>Original data source</b>	<b>Source scales</b>
Road network	ROADS centre-lines <a href="#">OSCAR Route-Manager</a> <sup>®</sup>	1:1250, 1:2500 and 1:10 000
Railways	Large-scale database	1:1250, 1:2500 and 1:10:000
County, district and London borough for England	<a href="#">Boundary-Line</a> <sup>™</sup>	1:10 000
Unitary authority areas for Wales	<a href="#">Boundary-Line</a>	1:10 000
Unitary authority areas for Scotland	<a href="#">Boundary-Line</a>	1:10 000
Coastline	<a href="#">Landranger</a> <sup>®</sup>	1:50 000
Developed land use areas and place names	<a href="#">Strategi</a> <sup>®</sup>	1:250 000
Hydrology	<a href="#">Strategi</a>	1:250 000
Woodlands	<a href="#">Strategi</a>	1:250 000
Gridded height	<a href="#">Land-Form PANORAMA</a> <sup>®</sup>	1:50 000

## Currency

Meridian 2 data is derived from the latest available versions of Ordnance Survey's databases. The Meridian 2 dataset will be refreshed annually commencing in January 2002.

The large and small scales databases are controlled by the revision criteria for topography that are defined by Ordnance Survey for the various geographical areas.

## Accuracy and resolution

The resolution of the data supplied is 1 metre. Meridian 2 data retains the same accuracy as the source data during its capture. However, it is not possible to calculate meaningful accuracy criteria for these data due to different source databases.

OSCAR Route-Manager has a 20 m filter applied to the centre line, which is supplied to 1 m resolution. The 20 m filter does not affect the positional accuracy of node points.

During the updating of OSCAR data there is a comparison buffer created – around the existing OSCAR data – to detect change. This buffer is set to 3 m either side of a feature, 5 m at each end, and 10% of the length.

Administrative areas and roads data have a 20 m lateral filter applied to the boundary and centre lines. The 20 m filter does not affect the positional accuracy of node points.

Features derived from the small-scale databases have been subjected to generalisation – information is cartographically represented in areas where accurate positional representation would cause confusing clutter on the viewed image. To maintain positional relationships such data has been further adjusted to fit the hierarchy where necessary.

## Completeness

During production, many checks are undertaken to ensure that data supplied to customers are both accurate and complete. During digital manipulation in creating the upgraded data, all sources of that data are checked against specification documentation to ensure that no features have been omitted or misaligned.

These quality control checks take the form of:

- visual checks by operators;
- independent quality assurance checks; and
- computer validation with the specification.

## Meridian general specifications

The following gives details of the product specification identity and their relationship to Ordnance Survey data capture specifications. Version details of these specifications are also stated.

<b>Product</b>	<b>Product specification</b>	
Meridian 2	Meridian_02.00	
<b>Transfer format specifications</b>		
Name	NTF (BS 7567)	DXF (Release 12)
Level	3	
Version	2	1
Issue Date	15 May 1992	1 January 1997





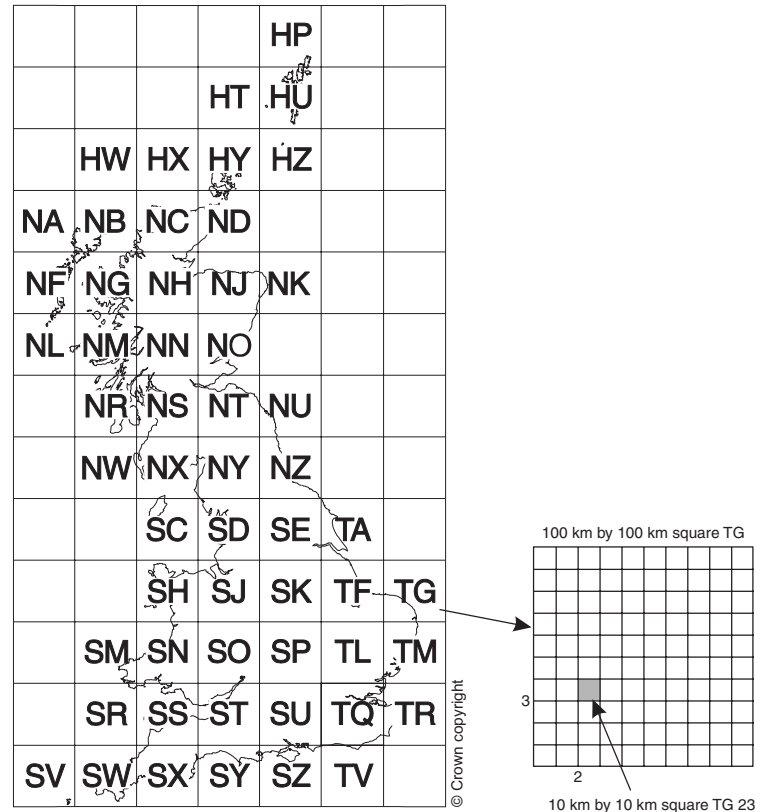
## Chapter 5

# The National Grid

Meridian 2 tiles are identified by quoting the National Grid reference of the south-west corner of the area they cover. The Ordnance Survey National Grid divides Great Britain into squares 100 km by 100 km. Each of these squares has a unique two-letter reference, for example, TG in the diagram below.

Each Meridian 2 10 km by 10 km tile is described by adding a two-digit reference to the 100 km by 100 km square reference, with the easting first followed by the northing, for example, TG23.

For additional information on how to use the National Grid, visit Ordnance Survey's web site at: [www.ordnancesurvey.co.uk](http://www.ordnancesurvey.co.uk). To navigate to the National Grid site, click on the *Education* icon in the menu and then on *National Grid*.





## Chapter 6 NTF explained

### An overview of Meridian 2 in NTF

This chapter gives a detailed breakdown of the data structure of Meridian 2 in NTF.

Meridian 2 data is supplied in the British Standard national format common to all Ordnance Survey's digital map data products – namely NTF – and is transferred in Level 3 as variable length records. An overview of the data structure of a Meridian 2 data file is on [page 6.2](#). The convention used for this diagram is in the industry standard adopted for Jackson Structured Programming (JSP).

The British Standard for NTF stipulates the following for Level 3:

'This level supports a variety of data models that may include network data, polygons, semantic relationships and complex features – for example, a school consisting of its buildings, boundaries and playing fields.'

This level is designed for:

- Transferring basic geometry and simple features through the use of geometry and feature records.
- Relating basic geometrical and topological elements to one or more features through the use of chain, polygon and complex line records.
- Combining features to form complex features through the use of collection and complex polygon records.
- Using text records both to relate text strings to features and cartographic output.
- Referencing and positioning external features, for example, raster data.

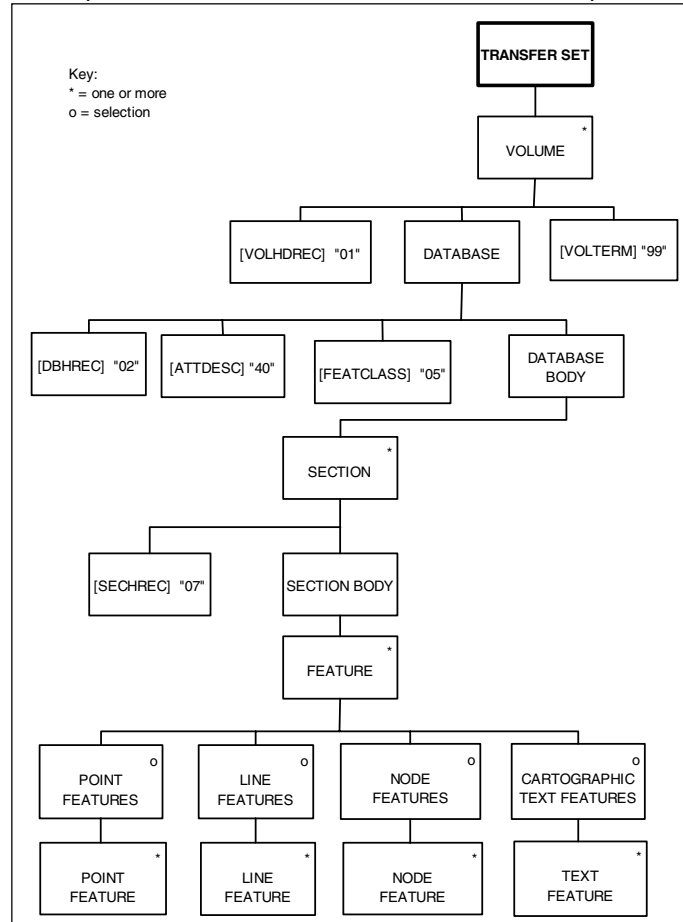
The record structure at this level may also be defined to be compatible with data in Levels 1 and 2.

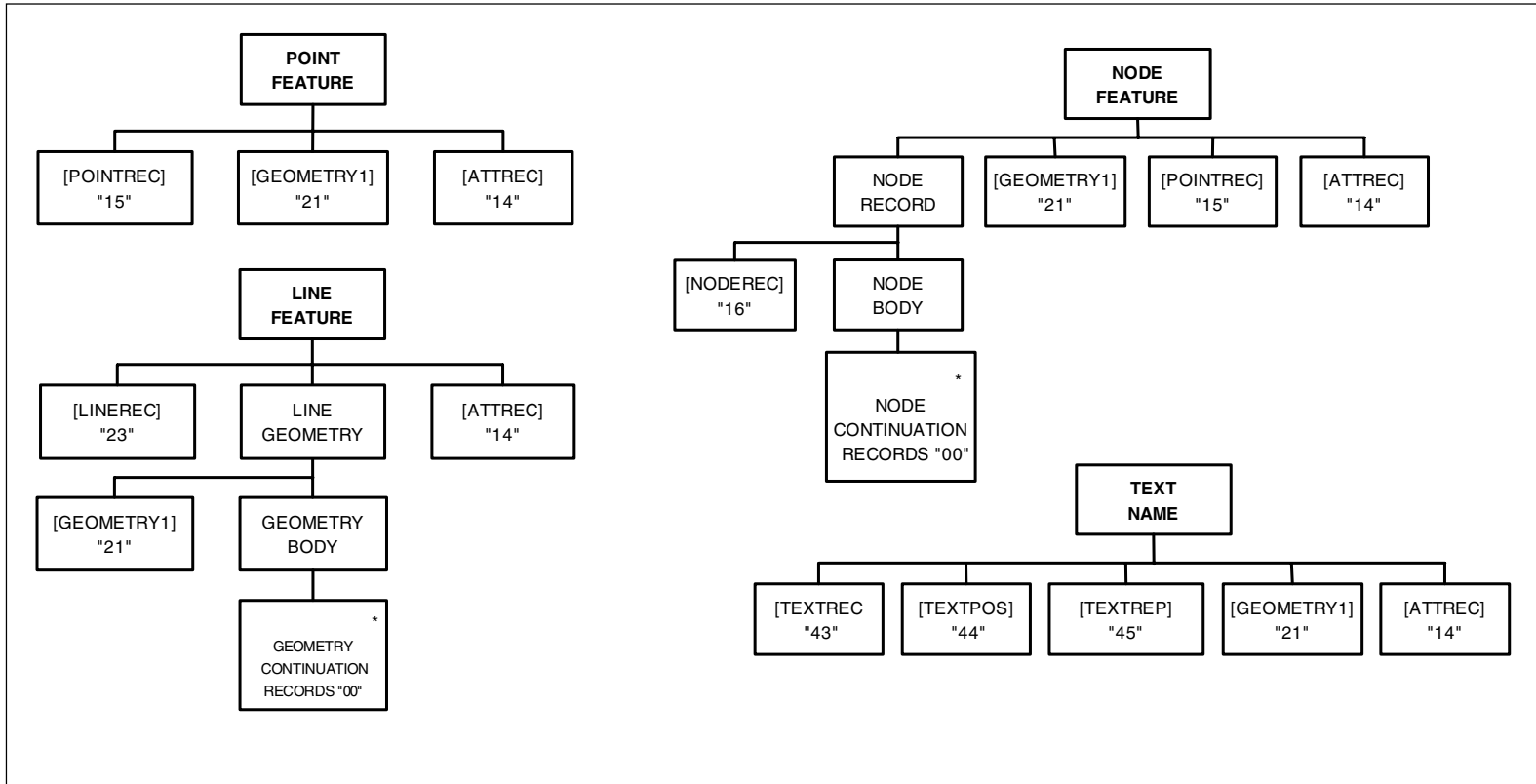
There are certain conventions used in this user guide, which are:

- [ ] Square brackets are placed around record names, for example, [VOLHDREC].
- { } A pair of braces denote field names, for example, {REC\_DESC} is the Record Descriptor field.
- [ ] 90 A two-digit number following square brackets denotes the record descriptor which uniquely identifies the record name between the brackets.
- <S> This is the space character (ASCII code 32).
- <3S> This denotes three successive space characters.
- % The percentage character (ASCII code 37).
- | This denotes a repeating group (ASCII code 124).

## Jackson structure

The following diagrams are examples of Meridian 2 files and no fixed record sequence or relationship is implied.





The governing body for the industry standard NTF is the British Standards Institution (BSI).

Their address is:

British Standards Institution  
389 Chiswick High Road  
LONDON  
W4 4AL

Phone: +44 (0)20 8996 9000

Fax: +44 (0)20 8996 7400

Email: [info@bsi-global.com](mailto:info@bsi-global.com)

Any queries relating to the Meridian 2 product should be referred to the Sales Information Helpdesk at the address given in [Contact details](#) at the beginning of this user guide.

## Transfer set structure

### Record size

NTF data is written to the output device in variable length records, with a maximum record length of 80 characters, which includes {CONT\_MARK} and {EOR}.

### Record terminator {EOR}

The end of record terminator is the percent (%) (ASCII 37) character for both formatted and unformatted media.

A transfer set normally equates to a single file except where continuation volumes are used when the transfer set exceeds the capacity of the media. The data the customer receives is in one or more transfer sets. Each transfer set starts with a [Volume Header Record](#) [VOLHDREC] and terminates with a [Volume Terminator Record](#) [VOLTERM].



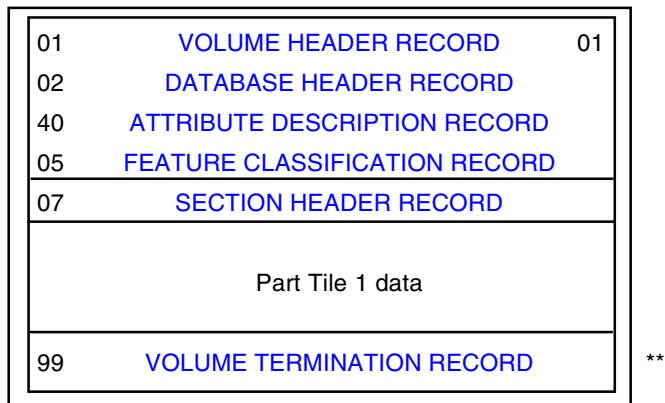
## Supply of data on formatted media

Data requested on CD is not blocked, but is written directly to the output device. The transfer set has one dataset and one section. One or more transfer sets are put onto the medium. A customer's order that is larger than the capacity of the medium is put onto two or more of that media. Continuation volumes are only be used if a transfer set is larger than the capacity of the medium.

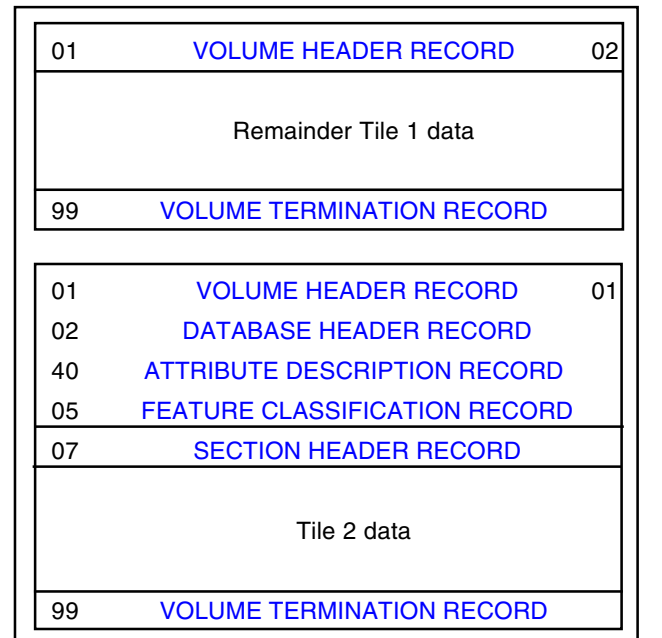
### Formatted media (transfer set less than media capacity)

01	VOLUME HEADER RECORD	01	
02	DATABASE HEADER RECORD		
40	ATTRIBUTE DESCRIPTION RECORD		
05	FEATURE CLASSIFICATION RECORD		
07	SECTION HEADER RECORD		
Tile 1 data			
99	VOLUME TERMINATION RECORD		*
01	VOLUME HEADER RECORD	01	
02	DATABASE HEADER RECORD		
40	ATTRIBUTE DESCRIPTION RECORD		
05	FEATURE CLASSIFICATION RECORD		
07	SECTION HEADER RECORD		
Tile 2 data			
99	VOLUME TERMINATION RECORD		*
etc.			
Tile n data			
99	VOLUME TERMINATION RECORD		*

\* '99End Of Transfer Set 0%'

**Formatted media (transfer set greater than media capacity)**


\*\* '99 End Of Volume 01 Transfer Set  
Continues On Volume 021%'



\* '99End Of Transfer Set 0%'

The beginning of each transfer set is structured with the following introductory, or leading, records:

**Database Header Record [DBHREC]** – this gives details of:

- 1 The database name.
- 2 NTF release date.
- 3 Feature classification table name.
- 4 Release date that applies to the whole of the transfer set.

**Attribute Description Record [ATTDESC]** – this lists and gives a description of the attributes that can be applied to features within the transfer set.

**Feature Classification Record [FEATCLASS]** – this lists and gives descriptions of all possible feature codes for the transfer set.

These introductory records are followed by the data requested by the customer which are contained in the *section*.

The *section* consists of two parts:

- 1 **Section Header Record [SECHREC]**: this gives the National Grid coordinates of the *section* and on unformatted media inform the customer that a new *section* is starting.
- 2 **Section body**: this comprises all the features within the *section*.

## Version management

Each version and release of all Meridian 2 products are defined by a unique product version number and release number – these are reflected in this user guide. The product version number relates to the specification of the data being supplied, and the release number relates to the release of the product.

The **product version number** takes the form **xx.yy**, where xx is the major product number, and yy is the minor change number. Thus version 02.00 would indicate that this is the major product version 02, and that the 00 indicates no minor amendment to the product specification.

The **release number** takes the form **xx.yy**, where xx is the sequential release within a year, and yy is the year of the release. Thus release 01.01 would indicate that this is the 1st data release in 2001.

The product version number and the release number are specified in the [Database Header Record](#) [DBHREC], as supplied in NTF.

## General

The following are the record definitions for the transfer of Meridian 2 data in NTF:

- [Volume Header Record](#) [VOLHDREC]
- [Database Header Record](#) [DBHREC]
- [Feature Classification Record](#) [FEATCLASS]
- [Attribute Description Record](#) [ATTDESC]
- [Section Header Record](#) [SECHREC]
- section body – see [Point and line features](#)
  - name detail
  - node detail
- [Volume Terminator Record](#) [VOLTERM]

## Section body

This comprises all the features within the tile that correspond to the feature types selected by the customer.

### Point and line features

#### Point feature

Each point feature is depicted by the use of the following records:

	Description in NTF
POINT RECORD	<a href="#">[POINTREC]</a>
GEOMETRY RECORD	<a href="#">[GEOMETRY1]</a>
ATTRIBUTE RECORD	[ATTREC]

#### Line feature

Each line feature is depicted by the use of the following records:

	Description in NTF
LINE RECORD	<a href="#">[LINEREC]</a>
GEOMETRY RECORD	[GEOMETRY1]
GEOMETRY CONTINUATION RECORDS	
ATTRIBUTE RECORDS	[ATTREC]

## Geometry records

Geometry records contain the coordinate position(s) in metres of the feature. Point features contain one coordinate pair; line features contain 2 or more coordinate pairs. Geometry Continuation Records are used where required. {X\_COORDS}, {Y\_COORDS} and {QPLAN} are treated as separate fields.

## Name detail

Each cartographically positioned name is depicted by the use of the following records:

	Description in NTF
TEXT RECORD	<a href="#">[TEXTREC]</a>
TEXT POSITION RECORD	<a href="#">[TEXTPOS]</a>
TEXT REPRESENTATION RECORD	<a href="#">[TEXTREP]</a>
GEOMETRY RECORD	<a href="#">[GEOMETRY1]</a>
ATTRIBUTE RECORD	[ATTREC]

### Records

Text details are only given when a name has been cartographically positioned. The [Attribute Record](#) [ATTREC] contains the definitive name and is pointed to by the [Text Record](#) [TEXTREC].

The [Text Record](#) [TEXTREC] points to the [Attribute Record](#) [ATTREC] and also points to the [Text Position Record](#) [TEXTPOS].

The [Text Position Record](#) [TEXTPOS] refers back to the [Text Record](#) [TEXTREC] and points to the [Geometry Record](#) [GEOMETRY 1] containing the coordinates of the digitised position. The [Text Position Record](#) [TEXTPOS] also points to the [Text Representation Record](#) [TEXTREP], which contains the standard digitising position and orientation of the text.

All other names are held as attributes only.

## Node detail

### Node feature

Each node feature is depicted by the use of the following records:

	Description in NTF
NODE RECORD	[NODEREC]
NODE CONTINUATION RECORD	
GEOMETRY RECORD	[GEOMETRY1]
POINT RECORD	[POINTREC]
ATTRIBUTE RECORD	[ATTREC]

All links in Meridian 2 terminate in explicit node records; each node is related to a point and its attributes via a common geometry record. This structure allows an attribute with a node within the constraints of NTF.

### Records

[Node Record](#) [NODEREC] transfers details of the bearings and number of lines that meet at a point or node.

The [Node Record](#) [NODEREC] contains references to each [Line Record](#) [LINEREC] that meets at that node and to the [Geometry Record](#) [GEOMETRY 1]. The [Geometry Record](#) [GEOMETRY 1] is referenced by the [Point Records](#) [POINTREC] containing the feature attributes of the node.

Where lines do not meet at a previously specified point feature, a special point feature is created.

The [Node Record](#) [NODEREC] can contain details of up to five line features that meet at a node. Further lines meeting at that node are written to the Node Continuation Record.

It is important to note that, although the [Node Record](#) contains references to its appropriate point and line features, the point and line features do not contain references to the node.

## Feature information relevant to NTF

### Point features

Point features can exist independently and at the junction or ends of lines. The point feature gives a position and attribute to the corresponding node.

### Line features

All line features, with the exception of where railways cross at different levels, are broken when they intersect one another within a layer.

**Note:** a layer is a subset of digital map data, selected on a basis other than position. For example, one layer might consist of all features relating to roads and another to railways.

The first and last coordinate pairs in a line correspond exactly with the start or end coordinates of any adjoining line(s).

A line cannot cross from one tile (10 km by 10 km square) to the next – it is split on the tile edge, see [Unique identifiers](#).

All linear features are continuous. Cartographic gaps are closed during the digitising process.

### Coordinates

Coordinate values and the number of coordinate pairs in a feature are transferred in the [GEOMETRY1] NTF record.

All coordinates within the data are expressed as strings of five numeric characters. Leading zeros are present to complete the five characters.

All coordinates are measured from the local origin, which is the south-west corner of the tile.



To convert coordinate data to full National Grid coordinates, add the coordinates of the feature to those of the south-west corner of the tile. The south-west corner coordinates are contained within the {X\_ORIG} and {Y\_ORIG} fields of the [Section Header Record](#) ([SECHREC] '07').

## Bearings

Bearings are transferred in the {ORIENT} field of the [Node Record](#) [NODEREC].

Bearings are National Grid bearings, in degrees, measured clockwise from grid north.

The start of line bearing, indicated by a value of 1 in the {DIR} field of the [Node Record](#) [NODEREC], is the bearing of the first segment of the line. The direction is from the start of the line to the next pair of coordinates or, if there are only two coordinate pairs, from the start to the end of the line.

The end of line bearing, indicated by a 2 in the {DIR} field, is the bearing of the last segment of the line. The direction is from the end of the feature to the last-minus-one pair of coordinates.

## Attribute codes

Attribute Codes provide supplementary information on a feature, providing such qualifying information as feature code, feature name, orientation and so on.

In NTF, the structure of user-defined attributes are described in the [Attribute Description Record](#) [ATTDESC].

The actual attribute detail of a record is written in the [Attribute Record](#) [ATTREC].

Attributes, which are used in the supply of Meridian 2 data, are:

- FC **Feature code** – contains the numeric feature code of the feature.
- OD **OSODR** – a unique identifier for links and nodes on road features.
- RN **Road number** – DETR route number.
- TR **Trunk road** indicator.
- RT **Roundabout** indicator.
- JN **Junction name** – the name of a road junction.
- LC **Left county** boundary indicator.
- RC **Right county** boundary indicator.
- LD **Left district\*** boundary indicator.
- RD **Right district\*** boundary indicator.
- PI **Global ID** – a unique identifier for administrative areas.
- DA **DLUA ID** – a unique identifier for a developed land use areas.
- PN **Proper name** – the definitive name for a developed land use area or railway station.
- RI **Rail ID** – a unique railway link identifier.
- SN **Settlement name** text.
- SI **Station ID** – a unique railway station identifier.
- NM **Admin name** – an administrative area name.
- TX **Text** – independent text.
- FA **Forest ID** – a unique identifier for forest areas.
- WA **Water area** – a unique identifier for water area.
- WI **Water link** – a unique identifier for water links.
- HT **Height ID** – a unique identifier for gridded height.

\* Includes London borough and unitary authority area.

## Unique identifiers

Unique identifiers are used to uniquely identify some features within Meridian 2. These are:

- **Ordnance Survey Roads Database Reference (OSODR)** – this uniquely identifies any road link or road node within the national ROADS database and is therefore compatible with the OSCAR family of products. Interchange of data between Meridian 2 and OSCAR is possible with software modification.
- **Railway and railway station identifiers** – these uniquely identify any railway link or railway station within the national Meridian 2 database.
- **Developed land use area identifier** – this uniquely identifies any developed land use area seed point within the national Meridian 2 database.
- **Global identifier** – this uniquely identifies any administrative area seed point within the 10 km by 10 km tile.
- **Water identifier** – this uniquely identifies the hydrology (inland water) seed.
- **Woodland identifier** – this uniquely identifies the woodland seed.

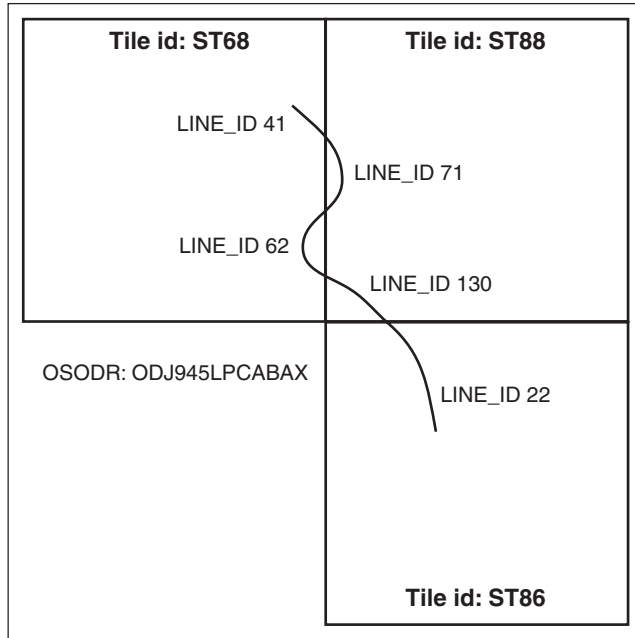
The unique identifiers are unique references and are maintained, except where there has been significant change to a feature.

The unique identifier may refer to several links representing a linear object across tiles, for example, a road or a railway, which may be chained together across tile edges. Thus, on adjoining tiles, there may be two or more links with the same unique identifier, [see figures 6.1 and 6.2](#).

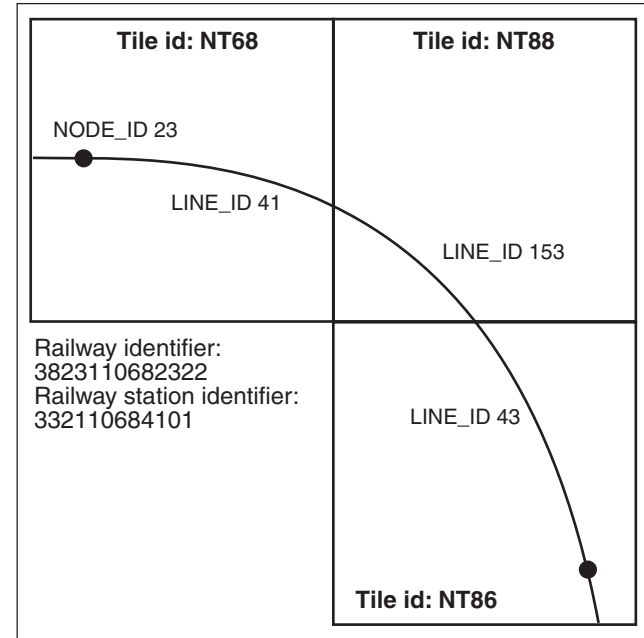
## Record IDs

The identifying fields for each NTF record, for example, NODE\_ID for [NODEREC], LINE\_ID for [LINEREC] and so on, are unique within each individual section (tile) supplied. They are not maintained between supplies.

**Figure 6.1:** Example of a unique identifier – OSODR



**Figure 6.2:** Example of unique identifier – a railway and railway station



## Feature layers

This section contains a list of all the valid features used with Meridian 2. The list contains a description of each feature, its feature type, its feature code (FC) and a list of the attributes, other than FC, which can be associated with that feature. The list is segmented by feature layer.

**Note:** all features carry the attribute FC as the feature code.

Feature description	Type	Code	Attribute(s)
<b>Roads</b>			
Motorway	Line	3000	FC, LL, NP, OD, PO, RN, TR, PN
A road	Line	3001	FC, LL, NP, OD, PO, RN, TR, PN
B road	Line	3002	FC, LL, NP, OD, PO, RN, TR, PN
Minor road	Line	3004	FC, LL, NP, OD, PO, RN, TR, PN
Road node	Point	3500	FC, NP, OD, PO, JN, RT, SN
Road edge node	Point	3501	FC, NP, OD, PO, JN, RT, SN
<b>Railways</b>			
Railway	Line	6140	FC, RI
Tunnelled railway	Line	6142	FC, RI
Railway station	Point	6155	FC, SI, PN
Railway node	Point	6730	FC
Railway edge node	Point	6731	FC
<b>Administrative areas and coastline</b>			
County boundary	Line	6401	FC, LC, RC
District* boundary	Line	6403	FC, LD, RD
County/district* boundary	Line	6405	FC, LC, RC, LD, RD
Neat line	Line	6800	FC, LC, RC, LD, RD
County seed	Point	6411	FC, PI, NM
District* seed	Point	6415	FC, PI, NM
Boundary node	Point	6710	FC
Boundary edge node	Point	6711	FC
Coastline	Line	6200	FC, LC, RC, LD, RD
Coastline node	Point	6740	FC
Coastline edge node	Point	6741	FC

<b>Feature description</b>	<b>Type</b>	<b>Code</b>	<b>Attribute(s)</b>
<b>Developed land use areas (DLUA)</b>			
DLUA boundary	Line	6300	FC
DLUA seed	Point	6310	FC, PN, DA
DLUA node	Point	6720	FC
DLUA edge node	Point	6721	FC
Neat line	Line	6801	FC
<b>Cartographic names</b>			
Place name	Point	6500	FC, TX
Station name	Point	6551	FC, TX
<b>Hydrology</b>			
Water feature river small	Line	6223	FC, WI, PN
Water feature river medium	Line	6224	FC, WI, PN
Water feature river large	Line	6225	FC, WI, PN
Water feature hidden water	Line	6230	FC, WI, PN
Water feature aqueduct	Line	6231	FC, WI, PN
Water feature dark link	Line	6232	FC, WI, PN
Water feature canal	Line	6243	FC, WI, PN
Water feature lake	Line	6255	FC, WI, PN
Area water seed	Point	6292	FC, WA
Water text	Point	6552	FC, TX
Water feature node	Point	6770	FC
Area water node	Point	6771	FC
Area water edge node	Point	6772	FC
Water feature edge node	Point	6773	FC
Area water neat line	Line	6803	FC

<b>Feature description</b>	<b>Type</b>	<b>Code</b>	<b>Attribute(s)</b>
<b>Woodlands</b>			
Woodland boundary	Line	6664	FC
Woodland seed	Point	6663	FC, FA, TX
Woodland node	Point	6750	FC
Woodland edge node	Point	6751	FC
Woodland neat line	Line	6802	FC
<b>Height</b>			
Gridded height	Point	6762	FC, HT

**Note:** \* Includes London borough and unitary authority areas.





## Chapter 7 Record structures for the transfer of Meridian 2 in NTF

### NTF Record List

This list comprises the valid record types used in the Meridian 2 NTF transfer Set.

Descriptor	Description	Record Name
01	<a href="#">Volume Header Record</a> – defines the donor and data type	[VOLHDREC]
02	<a href="#">Database Header Record</a> – transfers data about the database	[DBHREC]
05	<a href="#">Feature Classification Record</a> – defines data classifications	[FEATCLASS]
07	<a href="#">Section Header Record</a> – defines coordinate and structure types, unit scale, factors and so on	[SECHREC]
14	<a href="#">Attribute Record</a> – defines the attributes for line and point records	[ATTREC]
15	<a href="#">Point Record</a> – identifies the definition of node points	[POINTREC]
16	<a href="#">Node Record</a> – defines the topological relationship between links and nodes	[NODEREC]
21	<a href="#">Two-dimensional Geometry Record</a> – defines the two-dimensional geometry for a link or node	[GEOMETRY1]
23	<a href="#">Line Record</a> – identifies the definition of a link	[LINEREC]
40	<a href="#">Attribute Description Record</a> – defines attribute descriptions and their fields	[ATTDESC]
43	<a href="#">Text Record</a> – identifies the Text Position Record and Attribute Record	[TEXTREC]
44	<a href="#">Text Position Record</a> – identifies the Text Representation Record and Geometry Record	[TEXTPOS]
45	<a href="#">Text Representation Record</a> – defines the font, text height and digitised position	[TEXTREP]
90	<a href="#">Comment Record</a> – transfers change information or information about empty tiles	[COMMENT]
99	<a href="#">Volume Terminator Record</a> – defines the end of the transfer set	[VOLTERM]

**Note:** Where Meridian 2 height differs from Meridian 2 full dataset, a record example will be shown.

## Volume Header Record [VOLHDREC] 01

Field	Position	Format	Value example	Description
REC_DESC	01:02	A2	01	
DONOR	03:22	A20	ORDNANCE SURVEY<5S>	
RECIPIENT	23:42	A20	<20S>	Not used.
TRANDATE	43:50	DATE	yyyymmdd	Supply date.
SERIAL	51:54	I4	0000	Not used.
VOLNUM	55:56	I2	nn	Volume number 01 to 99.
NTFLEVEL	57:57	I1	3	NTF Level 3.
NTFVER	58:61	R4.2	0200	NTF Version 2.0.
NTFOR	62:62	A1	V	Variable length records.
EOR	63:63	A1	% or <S>	Sets [EOR] to%on formatted media or default % for formatted media.
DIVIDER	64:64	A1	\	Divider used to terminate variable length text fields.
CONT_MARK	65:65	I1	0	No further records.
EOR	66:66	A1	%	Record terminator.

### Record example:

01ORDNANCE SURVEY 2000090100000130200V \0%

1	2	3	4	5	6	7	8
1234567890	1234567890	1234567890	1234567890	1234567890	1234567890	1234567890	1234567890

Template

## Database Header Record [DBHREC] 02

### Record 1

Field	Position	Format	Value example	Description
REC_DESC	01:02	A2	02	Record type identifier.
DBNAME	03:22	A20	Meridian_02.00<6S>	Database name.
DDNAME	23:42	A20	DEFAULT_02.00<7S>	Standard data dictionary name.
DDATE	43:50	DATE	19920515	Release date of NTF version being used.
DDBASE	51:70	A20	<20S>	Not used.
DDBDATE	71:78	DATE	00000000	Not used.
CONT_MARK	79:79	I1	1	Continuation record follows.
EOR	80:80	A1	%	Record terminator.

### Record 2

Field	Position	Format	Value example	Description
REC_DESC	01:02	A2	00	
FCNAME	03:22	A20	Meridian_02.00<6S>	Data specification (product version).
FCDATE	23:30	DATE	20000901	Date of data specification.
DQNAME	31:50	A20	<20S>	Not used.
DQDATE	51:58	DATE	00000000	Not used.
DATA_MODEL	59:60	I2	00	
CONT_MARK	61:61	I1	0	No further records.
EOR	62:62	A1	%	Record terminator .





## Section Header Record [SECHREC] 07

### Record 1

Field	Position	Format	Value example	Description
REC_DESC	01:02	A2	07	
SECT_REF	03:12	A10		10 km by 10 km tile reference, for example, TQ24<6S>.
COORD_TYP	13:13	I1	2	Rectangular.
STRUCT_TYP	14:14	I1	1	Vector.
XYLEN	15:19	I5	00005	Five-character coordinate fields (to 1 metre).
XY_UNIT	20:20	I1	2	Metres.
XY_MULT	21:30	R10.3	0000001000	Default.
ZLEN	31:35	I5	00000	Not used.
Z_UNIT	36:36	I1	0	Not used.
Z_MULT	37:46	R10.3	0000001000	Not used.
X_ORIG	47:56	I10		X coordinates of south-west corner of unit.
Y_ORIG	57:66	I10		Y coordinates of south-west corner of unit.
Z_DATUM	67:76	I10	0000000000	Not used.
CONT_MARK	77:77	I1	1	Continuation record follows.
EOR	78:78	A1	%	Record terminator.

### Record 2

Field	Position	Format	Value example	Description
REC_DESC	01:02	A2	00	
XMIN	03:12	I10	0000000000	
YMIN	13:22	I10	0000000000	
XMAX	23:32	I10	0000010000	
YMAX	33:42	I10	0000010000	
XY_ACC	43:47	R5.2	00000	Not used.
Z_ACC	48:52	R5.2	00000	Not used.
SURV_DATE	53:60	DATE	00000000	Not used.
LAST_AMND	61:68	DATE	yyyymmdd	Date last amended.
COPYRIGHT	69:76	DATE	yyyymmdd	Copyright date.
CONT_MARK	77:77	I1	0	No further records.
EOR	78:78	A1	%	Record terminator.

**Record example:**

07TQ24 21000052000000100000000000000010000000520000000014000000000000001%  
000000000000000000000000000000001000000000100000000000000000000020000901200009010%

	1	2	3	4	5	6	7	8
1234567890	1234567890	1234567890	1234567890	1234567890	1234567890	1234567890	1234567890	1234567890

Template

## Attribute Record [ATTREC] 14 for road links

Field	Position	Format	Value example	Description
REC_DESC	01:02	A2	14	
ATT_ID	03:08	I6		Unique ID for record.
VAL_TYPE	09:10	A2	OD	
VALUE	11:23	A13		Unique ID (OSODR) for link.
VAL_TYPE	24:25	A2	FC	
VALUE	26:29	I4		Feature code.
VAL_TYPE	*.*	A2	LL	
VALUE	*.*	I5		Length of link.
VALUE TYPE	**	A2	NP	
VALUE	**	A12		Number of parent OSODRs.
I VALUE TYPE	**	A2	PO	
I VALUE	**	A13		Parent OSODRs.
VAL_TYPE	*.*	A2	PN	
VALUE	*.*	A*		Road name.
DIVIDER	*.*	A1	\	Divider.
VAL_TYPE	*.*	A2	RN	
VALUE	*.*	A*		Road number.
DIVIDER	*.*	A1	\	Divider.
VAL_TYPE	*.*	A2	TR	
VALUE	*.*	A1		Trunk road indicator.
CONT_MARK	*.*	I1	0	No further records
			or 1	or continuation record follows.
EOR	*.*	A1	%	Record terminator.

\* = variable integer.





## Attribute Record [ATTREC] 14 for road nodes

Field	Position	Format	Value example	Description
REC_DESC	01:02	A2	14	
ATT_ID	03:08	I6		Unique ID for record.
VAL_TYPE	09:10	A2	OD	
VALUE	11:23	A13		Unique ID (OSODR) for node.
VAL_TYPE	24:25	A2	FC	
VALUE	26:29	I4		Feature code.
VALUE TYPE	**	A2	NP	
VALUE	**	A*		Number of parent OSODRs.
VALUE TYPE	**	A2	PO	
VALUE	**	A*		Parent OSODRs.
VAL_TYPE	*.*	A2	JN	
VALUE	*.*	A*		Junction name.
DIVIDER	*.*	A1	\	Divider.
VAL_TYPE	*.*	A2	SN	
VALUE	*.*	A*		Settlement name.
DIVIDER	*.*	A1	\	Divider.
VALUE TYPE	**	A2	RT	
VALUE	**	A1		Roundabout.
CONT_MARK	*.*	I1	0 or 1	No further records or continuation record follows.
EOR	*.*	A1	%	Record terminator.

**Note:** \* = variable integer.



## Attribute Record [ATTREC] 14 for administrative area links (county, district, coastline and neat line)

Field	Position	Format	Value example	Description
REC_DESC	01:02	A2	14	
ATT_ID	03:08	I6		Unique attribute record identifier.
VAL_TYPE	09:10	A2	FC	
VALUE	11:14	I4		Feature code.
AL_TYPE	15:16	A2	LC	
VALUE	17:22	I6		Left county pointer to seed (optional).
AL_TYPE	23:24	A2	RC	
VALUE	25:30	I6		Right county pointer to seed (optional).
VAL_TYPE	31:32	A2	LD	
VALUE	33:38	I6		Left district pointer to seed (optional).
AL_TYPE	39:40	A2	RD	
VALUE	41:46	I6		Right district pointer to seed (optional).
CONT_MARK	47:47	I1	0	No further records.
EOR	48:48	A1	%	Record terminator.

### Record example:

14000014FC6405LC043050RC043084LD069234RD0697200%

	1	2	3	4	5	6	7	8
1	2	3	4	5	6	7	8	9
0	1	2	3	4	5	6	7	8
9	0	1	2	3	4	5	6	7
8	9	0	1	2	3	4	5	6
7	8	9	0	1	2	3	4	5
6	7	8	9	0	1	2	3	4
5	6	7	8	9	0	1	2	3
4	5	6	7	8	9	0	1	2
3	4	5	6	7	8	9	0	1
2	3	4	5	6	7	8	9	0
1	2	3	4	5	6	7	8	9
0	1	2	3	4	5	6	7	8

Template

## Attribute Record [ATTREC] 14 for administrative area points and/or seeds

Field	Position	Format	Value example	Description
REC_DESC	01:02	A2	14	
ATT_ID	03:08	I6		Unique attribute record identifier.
VAL_TYPE	09:10	A2	FC	
VALUE	11:14	I4		Feature code.
VAL_TYPE	15:16	A2	PI	
VALUE	17:22	I6		Unique global (seed) identifier.
VAL_TYPE	23:24	A2	NM	
VALUE	25:*	A*		Administrative area name.
DIVIDER	*.*	A1	\	Divider.
CONT_MARK	*.*	I1	0 or 1	No further records or continuation record follows.
EOR	*.*	A1	%	Record terminator.

**Note:** \* = variable integer.

### Record example:

14000032FC6411PI043050NMHAMPSHIRE COUNTY\0%

	1	2	3	4	5	6	7	8
1	2	3	4	5	6	7	8	9
0	1	2	3	4	5	6	7	8
9	0	1	2	3	4	5	6	7
8	9	0	1	2	3	4	5	6
7	8	9	0	1	2	3	4	5
6	7	8	9	0	1	2	3	4
5	6	7	8	9	0	1	2	3
4	5	6	7	8	9	0	1	2
3	4	5	6	7	8	9	0	1
2	3	4	5	6	7	8	9	0
1	2	3	4	5	6	7	8	9
0	1	2	3	4	5	6	7	8

Template

## Attribute Record [ATTREC] 14 for nodes (administrative areas, developed land use area, coastline and railway, hydrology and woodlands) and/or edge nodes (all layers)

Field	Position	Format	Value example	Description
REC_DESC	01:02	A2	14	
ATT_ID	03:08	I6		Unique attribute record identifier.
VAL_TYPE	09:10	A2	FC	
VALUE	11:14	I4		Feature code.
CONT_MARK	15:15	I1	0	No further records.
EOR	16:16	A1	%	Record terminator.

## Attribute Record [ATTREC] 14 for developed land use area links

Field	Position	Format	Value example	Description
REC_DESC	01:02	A2	14	
ATT_ID	03:08	I6		Unique attribute record identifier.
VAL_TYPE	09:10	A2	FC	
VALUE	11:14	I4		Feature code.
CONT_MARK	15:15	I1	0	No further records.
EOR	16:16	A1	%	Record terminator.



## Attribute Record [ATTREC] 14 for cartographic name text

Field	Position	Format	Value example	Description
REC_DESC	01:02	A2	14	
ATT_ID	03:08	I6		Unique attribute record identifier.
VAL_TYPE	09:10	A2	FC	
VALUE	11:14	I4		Feature code.
VAL_TYPE	15:16	A2	TX	
VALUE	17:*	A*		Text string.
DIVIDER	*:*	A1	\	Divider.
CONT_MARK	*:*	I1	0 or 1 <i>or</i> 1	No further records or continuation record follows.
EOR	*:*	A1	%	Record terminator.

**Note:** \* = variable

### Record example:

14000012FC6500TXANDOVER\0%

	1	2	3	4	5	6	7	8
1	2	3	4	5	6	7	8	9
0	1	2	3	4	5	6	7	8
9	0	1	2	3	4	5	6	7
8	9	0	1	2	3	4	5	6
7	8	9	0	1	2	3	4	5
6	7	8	9	0	1	2	3	4
5	6	7	8	9	0	1	2	3
4	5	6	7	8	9	0	1	2
3	4	5	6	7	8	9	0	1
2	3	4	5	6	7	8	9	0
1	2	3	4	5	6	7	8	9
0	1	2	3	4	5	6	7	8

Template



## Attribute Record [ATTREC] 14 for railway links

Field	Position	Format	Value example	Description
REC_DESC	01:02	A2	14	
ATT_ID	03:08	I6		Unique attribute record identifier.
VAL_TYPE	09:10	A2	FC	
VALUE	11:14	I4		Feature code.
VAL_TYPE	15:16	A2	RI	
VALUE	17:29	A13		Unique railway link identifier.
CONT_MARK	30:30	I1	0	No further records.
EOR	31:31	A1	%	Record terminator.

### Record example:

14000002FC6140RI41842002735110%

	1	2	3	4	5	6	7	8
1	2	3	4	5	6	7	8	9
0	1	2	3	4	5	6	7	8
9	0	1	2	3	4	5	6	7
8	9	0	1	2	3	4	5	6
7	8	9	0	1	2	3	4	5
6	7	8	9	0	1	2	3	4
5	6	7	8	9	0	1	2	3
4	5	6	7	8	9	0	1	2
3	4	5	6	7	8	9	0	1
2	3	4	5	6	7	8	9	0
1	2	3	4	5	6	7	8	9
0	1	2	3	4	5	6	7	8
9	0	1	2	3	4	5	6	7
8	9	0	1	2	3	4	5	6
7	8	9	0	1	2	3	4	5
6	7	8	9	0	1	2	3	4
5	6	7	8	9	0	1	2	3
4	5	6	7	8	9	0	1	2
3	4	5	6	7	8	9	0	1
2	3	4	5	6	7	8	9	0
1	2	3	4	5	6	7	8	9
0	1	2	3	4	5	6	7	8
9	0	1	2	3	4	5	6	7
8	9	0	1	2	3	4	5	6
7	8	9	0	1	2	3	4	5
6	7	8	9	0	1	2	3	4
5	6	7	8	9	0	1	2	3
4	5	6	7	8	9	0	1	2
3	4	5	6	7	8	9	0	1
2	3	4	5	6	7	8	9	0
1	2	3	4	5	6	7	8	9
0	1	2	3	4	5	6	7	8
9	0	1	2	3	4	5	6	7
8	9	0	1	2	3	4	5	6
7	8	9	0	1	2	3	4	5
6	7	8	9	0	1	2	3	4
5	6	7	8	9	0	1	2	3
4	5	6	7	8	9	0	1	2
3	4	5	6	7	8	9	0	1
2	3	4	5	6	7	8	9	0
1	2	3	4	5	6	7	8	9
0	1	2	3	4	5	6	7	8
9	0	1	2	3	4	5	6	7
8	9	0	1	2	3	4	5	6
7	8	9	0	1	2	3	4	5
6	7	8	9	0	1	2	3	4
5	6	7	8	9	0	1	2	3
4	5	6	7	8	9	0	1	2
3	4	5	6	7	8	9	0	1
2	3	4	5	6	7	8	9	0
1	2	3	4	5	6	7	8	9
0	1	2	3	4	5	6	7	8
9	0	1	2	3	4	5	6	7
8	9	0	1	2	3	4	5	6
7	8	9	0	1	2	3	4	5
6	7	8	9	0	1	2	3	4
5	6	7	8	9	0	1	2	3
4	5	6	7	8	9	0	1	2
3	4	5	6	7	8	9	0	1
2	3	4	5	6	7	8	9	0
1	2	3	4	5	6	7	8	9
0	1	2	3	4	5	6	7	8
9	0	1	2	3	4	5	6	7
8	9	0	1	2	3	4	5	6
7	8	9	0	1	2	3	4	5
6	7	8	9	0	1	2	3	4
5	6	7	8	9	0	1	2	3
4	5	6	7	8	9	0	1	2
3	4	5	6	7	8	9	0	1
2	3	4	5	6	7	8	9	0
1	2	3	4	5	6	7	8	9
0	1	2	3	4	5	6	7	8
9	0	1	2	3	4	5	6	7
8	9	0	1	2	3	4	5	6
7	8	9	0	1	2	3	4	5
6	7	8	9	0	1	2	3	4
5	6	7	8	9	0	1	2	3
4	5	6	7	8	9	0	1	2
3	4	5	6	7	8	9	0	1
2	3	4	5	6	7	8	9	0
1	2	3	4	5	6	7	8	9
0	1	2	3	4	5	6	7	8
9	0	1	2	3	4	5	6	7
8	9	0	1	2	3	4	5	6
7	8	9	0	1	2	3	4	5
6	7	8	9	0	1	2	3	4
5	6	7	8	9	0	1	2	3
4	5	6	7	8	9	0	1	2
3	4	5	6	7	8	9	0	1
2	3	4	5	6	7	8	9	0
1	2	3	4	5	6	7	8	9
0	1	2	3	4	5	6	7	8
9	0	1	2	3	4	5	6	7
8	9	0	1	2	3	4	5	6
7	8	9	0	1	2	3	4	5
6	7	8	9	0	1	2	3	4
5	6	7	8	9	0	1	2	3
4	5	6	7	8	9	0	1	2
3	4	5	6	7	8	9	0	1
2	3	4	5	6	7	8	9	0
1	2	3	4	5	6	7	8	9
0	1	2	3	4	5	6	7	8
9	0	1	2	3	4	5	6	7
8	9	0	1	2	3	4	5	6
7	8	9	0	1	2	3	4	5
6	7	8	9	0	1	2	3	4
5	6	7	8	9	0	1	2	3
4	5	6	7	8	9	0	1	2
3	4	5	6	7	8	9	0	1
2	3	4	5	6	7	8	9	0
1	2	3	4	5	6	7	8	9
0	1	2	3	4	5	6	7	8
9	0	1	2	3	4	5	6	7
8	9	0	1	2	3	4	5	6
7	8	9	0	1	2	3	4	5
6	7	8	9	0	1	2	3	4
5	6	7	8	9	0	1	2	3
4	5	6	7	8	9	0	1	2
3	4	5	6	7	8	9	0	1
2	3	4	5	6	7	8	9	0
1	2	3	4	5	6	7	8	9
0	1	2	3	4	5	6	7	8
9	0	1	2	3	4	5	6	7
8	9	0	1	2	3	4	5	6
7	8	9	0	1	2	3	4	5
6	7	8	9	0	1	2	3	4
5	6	7	8	9	0	1	2	3
4	5	6	7	8	9	0	1	2
3	4	5	6	7	8	9	0	1
2	3	4	5	6	7	8	9	0
1	2	3	4	5	6	7	8	9
0	1	2	3	4	5	6	7	8
9	0	1	2	3	4	5	6	7
8	9	0	1	2	3	4	5	6
7	8	9	0	1	2	3	4	5
6	7	8	9	0	1	2	3	4
5	6	7	8	9	0	1	2	3
4	5	6	7	8	9	0	1	2
3	4	5	6	7	8	9	0	1
2	3	4	5	6	7	8	9	0
1	2	3	4	5	6	7	8	9
0	1	2	3	4	5	6	7	8
9	0	1	2	3	4	5	6	7
8	9	0	1	2	3	4	5	6
7	8	9	0	1	2	3	4	5
6	7	8	9	0	1	2	3	4
5	6	7	8	9	0	1	2	3
4	5	6	7	8	9	0	1	2
3	4	5	6	7	8	9	0	1
2	3	4	5	6	7	8	9	0
1	2	3	4	5	6	7	8	9
0	1	2	3	4	5	6	7	8
9	0	1	2	3	4	5	6	7
8	9	0	1	2	3	4	5	6
7	8	9	0	1	2	3	4	5
6	7	8	9	0	1	2	3	4
5	6	7	8	9	0	1	2	3
4	5	6	7	8	9	0	1	2
3	4	5	6	7	8	9	0	1
2	3	4	5	6	7	8	9	0
1	2	3	4	5	6	7	8	9
0	1	2	3	4	5	6	7	8
9	0	1	2	3	4	5	6	7
8	9	0	1	2	3	4	5	6
7	8	9	0	1	2	3	4	5
6	7	8	9	0	1	2	3	4
5	6	7						

## Attribute Record [ATTREC] 14 for railway station nodes

Field	Position	Format	Value example	Description
REC_DESC	01:02	A2	14	
ATT_ID	03:08	I6		Unique attribute record identifier.
VAL_TYPE	09:10	A2	FC	
VALUE	11:14	I4		Feature code.
VAL_TYPE	15:16	A2	SI	
VALUE	17:29	A13		Unique railway station identifier.
VAL_TYPE	30:31	A2	PN	
VALUE	32:*	A*		Station name.
DIVIDER	*.*	A1	\	Divider
CONT_MARK	*.*	I1	0	No further records
			or 1	or continuation record follows.
EOR	*.*	A1	%	Record terminator.

**Note:** \* = variable integer.

### Record example:

14000003FC6155SI4169010274901PNSandling Station\0%

	1	2	3	4	5	6	7	8
1	2	3	4	5	6	7	8	9
0	1	2	3	4	5	6	7	8
1	2	3	4	5	6	7	8	9
0	1	2	3	4	5	6	7	8
1	2	3	4	5	6	7	8	9
0	1	2	3	4	5	6	7	8
1	2	3	4	5	6	7	8	9
0	1	2	3	4	5	6	7	8
1	2	3	4	5	6	7	8	9
0	1	2	3	4	5	6	7	8
1	2	3	4	5	6	7	8	9
0	1	2	3	4	5	6	7	8
1	2	3	4	5	6	7	8	9
0	1	2	3	4	5	6	7	8
1	2	3	4	5	6	7	8	9
0	1	2	3	4	5	6	7	8
1	2	3	4	5	6	7	8	9
0	1	2	3	4	5	6	7	8
1	2	3	4	5	6	7	8	9
0	1	2	3	4	5	6	7	8
1	2	3	4	5	6	7	8	9
0	1	2	3	4	5	6	7	8
1	2	3	4	5	6	7	8	9
0	1	2	3	4	5	6	7	8

Template

## Attribute Record [ATTREC] 14 for water feature (river, small)

Field	Position	Format	Value example	Description
REC_DESC	01:02	A2	14	
ATT_ID	03:08	I6		Unique attribute record identifier.
VAL_TYPE	09:10	A2	FC	
VALUE	11:14	I4		Feature code.
VAL_TYPE	15:16	A2	WI	
VALUE	17:29	A13		Unique water feature identifier.
VAL_TYPE	30:31	A2	PN	
VALUE	32:*	A*		River name (optional).
DIVIDER	*.*	A1	\	Divider.
CONT_MARK	*.*	I1	0 or 1	No further records or continuation record follows.
EOR	*.*	A1	%	Record terminator.

**Note:** \* = variable integer.

### Record example:

14000003FC6223WI61690502790901PNRiver Lydden\0%

	1	2	3	4	5	6	7	8
1	2	3	4	5	6	7	8	9
0	1	2	3	4	5	6	7	8
9	0	1	2	3	4	5	6	7
8	9	0	1	2	3	4	5	6
7	8	9	0	1	2	3	4	5
6	7	8	9	0	1	2	3	4
5	6	7	8	9	0	1	2	3
4	5	6	7	8	9	0	1	2
3	4	5	6	7	8	9	0	1
2	3	4	5	6	7	8	9	0
1	2	3	4	5	6	7	8	9
0	1	2	3	4	5	6	7	8

Template

**Note:** The WI identifier in the record example is fictional and does not relate to River Lydden.

## Attribute Record [ATTREC] 14 for water area seeds

Field	Position	Format	Value example	Description
REC_DESC	01:02	A2	14	
ATT_ID	03:08	I6		Unique attribute record identifier.
VAL_TYPE	09:10	A2	FC	
VALUE	11:14	I4		Feature code.
VAL_TYPE	15:16	A2	WA	
VALUE	17:22	I6		Unique water area (seed) identifier.
VAL_TYPE	23:24	A2	PN	
VALUE	25:*	A*		Water area name (where applicable).
DIVIDER	*.*	A1	\	Divider.
CONT_MARK	*.*	I1	0 or 1	No further records or continuation record follows.
EOR	*.*	A1	%	Record terminator.

**Note:** \* = variable integer.

### Record example:

14000032FC6292WA053050PNULLSWATER\0%

	1	2	3	4	5	6	7	8
1	2	3	4	5	6	7	8	9
0	1	2	3	4	5	6	7	8
9	0	1	2	3	4	5	6	7
8	9	0	1	2	3	4	5	6
7	8	9	0	1	2	3	4	5
6	7	8	9	0	1	2	3	4
5	6	7	8	9	0	1	2	3
4	5	6	7	8	9	0	1	2
3	4	5	6	7	8	9	0	1
2	3	4	5	6	7	8	9	0
1	2	3	4	5	6	7	8	9
0	1	2	3	4	5	6	7	8

Template

**Note:** The WI identifier in the record example is fictional and does not relate to Ullswater.

## Attribute Record [ATTREC] 14 for administrative area points and/or seeds

Field	Position	Format	Value example	Description
REC_DESC	01:02	A2	14	
ATT_ID	03:08	I6		Unique attribute record identifier.
VAL_TYPE	09:10	A2	FC	
VALUE	11:14	I4		Feature code.
VAL_TYPE	15:16	A2	PI	
VALUE	17:22	I6		Unique global (seed) identifier.
VAL_TYPE	23:24	A2	NM	
VALUE	25:*	A*		Admin area name.
DIVIDER	*.*	A1	\	Divider.
CONT_MARK	*.*	I1	0 or 1	No further records or continuation record follows.
EOR	*.*	A1	%	Record terminator.

**Note:** \* = variable integer.

### Record example:

14000032FC6411PI043050NMHAMPSHIRE COUNTY\0%

	1	2	3	4	5	6	7	8
1	2	3	4	5	6	7	8	9
0	1	2	3	4	5	6	7	8
9	0	1	2	3	4	5	6	7
8	9	0	1	2	3	4	5	6
7	8	9	0	1	2	3	4	5
6	7	8	9	0	1	2	3	4
5	6	7	8	9	0	1	2	3
4	5	6	7	8	9	0	1	2
3	4	5	6	7	8	9	0	1
2	3	4	5	6	7	8	9	0
1	2	3	4	5	6	7	8	9
0	1	2	3	4	5	6	7	8

Template

## Attribute Record [ATTREC] 14 for gridded height point

Field	Position	Format	Value example	Description
REC_DESC	01:02	A2	14	
ATT_ID	03:08	I6		Unique attribute record identifier.
VAL_TYPE	09:10	A2	FC	
VALUE	11:14	I4		Feature code.
VAL_TYPE	15:16	A2	HT	
VALUE	17:24	I8		Height attribute.
CONT_MARK	25:25	I1	0 or 1	No further records or continuation record follows.
EOR	26:26	A1	%	Record terminator.

**Note:** \* = variable integer.

### Record example:

14000090FC6762HT000000070%

	1	2	3	4	5	6	7	8
1	2	3	4	5	6	7	8	9
0	1	2	3	4	5	6	7	8
9	0	1	2	3	4	5	6	7
8	9	0	1	2	3	4	5	6
7	8	9	0	1	2	3	4	5
6	7	8	9	0	1	2	3	4
5	6	7	8	9	0	1	2	3
4	5	6	7	8	9	0	1	2
3	4	5	6	7	8	9	0	1
2	3	4	5	6	7	8	9	0
1	2	3	4	5	6	7	8	9
0	1	2	3	4	5	6	7	8

Template

## Point Feature Record [POINTREC] 15

Field	Position	Format	Value example	Description
REC_DESC	01:02	A2	15	
POINT_ID	03:08	I6		Unique point record identifier.
GEOM_ID	09:14	I6		Pointer to [GEOMETRY1] record.
NUM_ATT	15:16	I2	01	
ATT_ID	17:22	I6		Pointer to [ATTREC] record.
CONT_MARK	23:23	I1	0	No further records.
EOR	24:24	A1	%	Record terminator.

### Record example:

15000027004804010048040%

	1	2	3	4	5	6	7	8																																																															
1	2	3	4	5	6	7	8	9	1	2	3	4	5	6	7	8	9	1	2	3	4	5	6	7	8	9	1	2	3	4	5	6	7	8	9	1	2	3	4	5	6	7	8	9	1	2	3	4	5	6	7	8	9	1	2	3	4	5	6	7	8	9	1	2	3	4	5	6	7	8	9

Template

## Node Record [NODEREC] 16

Field	Position	Format	Value example	Description
REC_DESC	01:02	A2	16	
NODE_ID	03:08	I6		Unique node record identifier.
GEOM_ID	09:14	I6		Pointer to [GEOMETRY1] record of point feature.
NUM_LINKS	15:18	I4	>0	
I DIR	*.*	I1	1 or 2	1 for start of link or 2 for end of link.
I GEOM_ID	*.*	I6		Pointer to [GEOMETRY1] of link.
I ORIENT	*.*	R4,1		Bearing of first/last segment of link clockwise from grid north (not used for roads).
I LEVEL	*.*	I1	0 or 1	Link level at node (roads only).
CONT_MARK	*.*	I1	0 or 1	Link level at node for all other layers.
EOR	*.*	A1	%	No further records or continuation record follows.
				Record terminator.

**Note:** \* = variable integer.

### Record example:

1600000800480400012004921226000%

	1	2	3	4	5	6	7	8
1	2	3	4	5	6	7	8	9
0	1	2	3	4	5	6	7	8
9	0	1	2	3	4	5	6	7
8	9	0	1	2	3	4	5	6
7	8	9	0	1	2	3	4	5
6	7	8	9	0	1	2	3	4
5	6	7	8	9	0	1	2	3
4	5	6	7	8	9	0	1	2
3	4	5	6	7	8	9	0	1
2	3	4	5	6	7	8	9	0
1	2	3	4	5	6	7	8	9
0	1	2	3	4	5	6	7	8

Template

### Notes:

I indicates repeating group.

The pair of fields {VAL\_TYPE} and {VALUE} will repeat to specify all the attributes required. It may be necessary to utilise a continuation record to specify all attributes.



## Two-dimensional Geometry Record [GEOMETRY1] 21 associated with POINTREC

Field	Position	Format	Value example	Description
REC_DESC	01:02	A2	21	
GEOM_ID	03:08	I6		Unique geometry record identifier.
GTYPE	09:09	I1	1	Point feature.
NUM_COORD	10:13	I4	0001	Point has one coordinate pair.
X_COORD	14:18	I5	X co-ordinate	
Y_COORD	19:23	I5	Y co-ordinate	
QPLAN	24:24	A1	<S>	Not used.
CONT_MARK	25:25	I1	0	No further records.
EOR	26:26	A1	%	Record terminator.

### Record example:

21000031100011564044030 0%

	1	2	3	4	5	6	7	8
1	2	3	4	5	6	7	8	
9	0	1	2	3	4	5	6	7
8	9	0	1	2	3	4	5	6
7	8	9	0	1	2	3	4	5
6	7	8	9	0	1	2	3	4
5	6	7	8	9	0	1	2	3
4	5	6	7	8	9	0	1	2
3	4	5	6	7	8	9	0	1
2	3	4	5	6	7	8	9	0
1	2	3	4	5	6	7	8	9

Template

## Two-dimensional Geometry Record [GEOMETRY1] 21 associated with LINEREC

Field	Position	Format	Value example	Description
REC_DESC	01:02	A2	21	
GEOM_ID	03:08	I6		Unique geometry record identifier.
GTYPE	09:09	I1	2	Line feature.
NUM_COORD	10:13	I4		Number of coordinate pairs, in range 0002–9999.
I X_COORD	14:18	I5	X coordinate	Repeated until {NUM_COORD} has been transferred.
I Y_COORD	19:23	I5	Y coordinate	Repeated until {NUM_COORD} has been transferred.
I QPLAN	24:24	A1	<S>	Not used.
CONT_MARK	*:*	I1	0 or 1	No further records or continuation record follows.
EOR	*:*	A1	%	Record terminator.

### Notes:

\* = variable integer.

This record may contain many CONTINUATION 00 records.

I indicates a repeating group.

The pair of fields {VAL\_TYPE} and {VALUE} will repeat to specify all the attributes required. It may be necessary to utilise a continuation record to specify all attributes.

## Line Feature Record [LINEREC] 23

Field	Position	Format	Value example	Description
REC_DESC	01:02	A2	23	
LINE_ID	03:08	I6		Unique line record identifier.
GEOM_ID	09:14	I6		Pointer to [GEOMETRY1] record.
NUM_ATT	15:16	I2	01	
ATT_ID	17:22	I6		Pointer to [ATTREC] record.
CONT_MARK	23:23	I1	0	No further records.
EOR	24:24	A1	%	Record terminator.

### Record example:

23004804005369010053690%

	1	2	3	4	5	6	7	8																																																																								
1	2	3	4	5	6	7	8	9	1	2	3	4	5	6	7	8	9	1	2	3	4	5	6	7	8	9	1	2	3	4	5	6	7	8	9	1	2	3	4	5	6	7	8	9	1	2	3	4	5	6	7	8	9	1	2	3	4	5	6	7	8	9	1	2	3	4	5	6	7	8	9	1	2	3	4	5	6	7	8	9

Template







## Text Representation Record [TEXTREP] 45

Field	Position	Format	Value example	Description
REC_DESC	01:02	A2	45	
TEXR_ID	03:08	I6		Unique text representation record identifier – cross reference from [TEXTPOS].
FONT	09:12	I4	0004	Text font Identity.
TEXT_HT	13:15	R3,1		Text height in millimetres.
DIG_POSTN	16:16	I1		Digitising position 0–8.
ORIENT	17:20	R4,1		Anticlockwise from grid east.
CONT_MARK	23:23	I1	0	No further records.
EOR	24:24	A1	%	Record terminator.

### Record example:

450000070004020300000%

	1	2	3	4	5	6	7	8
1234567890	1234567890	1234567890	1234567890	1234567890	1234567890	1234567890	1234567890	1234567890

Template

## Comment Record [COMMENT] 90

Field	Position	Format	Value example	Description
REC_DESC	01:02	A2	90	
RECORD_TYPE	03:04	I2		Changed NTF record type.
RECORD_ID	05:17	A13		Unique id (OSODR).
CHANGE_TYPE	18:18	A1	D or I or U	Type of change.
CONT_MARK	19:19	I1	0	No further records.
EOR	20:20	A1	%	Record terminator.

### Record example:

902301J945LPCABAXU0%

	1	2	3	4	5	6	7	8
1	2	3	4	5	6	7	8	9
0	1	2	3	4	5	6	7	8
9	0	1	2	3	4	5	6	7
8	9	0	1	2	3	4	5	6
7	8	9	0	1	2	3	4	5
6	7	8	9	0	1	2	3	4
5	6	7	8	9	0	1	2	3
4	5	6	7	8	9	0	1	2
3	4	5	6	7	8	9	0	1
2	3	4	5	6	7	8	9	0
1	2	3	4	5	6	7	8	9
0	1	2	3	4	5	6	7	8

Template

Field	Position	Format	Value example	Description
REC_DESC	01:02	A2	90	
FREE_TEXT	03: *	A*	NO OSCAR DATA FOR THIS TILE	
CONT_MARK	*.*	I1	0	No further records.
EOR	*.*	A1	%	Record terminator.

\* = variable integer.

### Record example:

90NO OSCAR DATA FOR THIS TILE0%

	1	2	3	4	5	6	7	8
1	2	3	4	5	6	7	8	9
0	1	2	3	4	5	6	7	8
9	0	1	2	3	4	5	6	7
8	9	0	1	2	3	4	5	6
7	8	9	0	1	2	3	4	5
6	7	8	9	0	1	2	3	4
5	6	7	8	9	0	1	2	3
4	5	6	7	8	9	0	1	2
3	4	5	6	7	8	9	0	1
2	3	4	5	6	7	8	9	0
1	2	3	4	5	6	7	8	9
0	1	2	3	4	5	6	7	8

Template



## Volume Terminator Record [VOLTERM] 99

Field	Position	Format	Value example	Description
_DESC	01:02	A2	99	
FREE_TEXT	03:*	A*		See note below.
CONT_VOL	*+1:*+1	I1	0 or 1	No continuation volume or continuation volume follows.
EOR	*+2:*+2	A1	%	Record terminator.

**Notes:** If there are further volume(s) to follow then the FREE\_TEXT field comprises the following message:  
 `End Of Volume (nn). Transfer Set Continues On Volume (nn+1)´

If there are no further volumes then the FREE\_TEXT field will read:  
 `End Of Transfer Set´

\* = variable integer.

### Record examples:

99End Of Volume 01 Transfer Set Continues On Volume 021%

	1	2	3	4	5	6	7	8
1	2	3	4	5	6	7	8	9
0	1	2	3	4	5	6	7	8
1	2	3	4	5	6	7	8	9
2	3	4	5	6	7	8	9	0
3	4	5	6	7	8	9	0	1
4	5	6	7	8	9	0	1	2
5	6	7	8	9	0	1	2	3
6	7	8	9	0	1	2	3	4
7	8	9	0	1	2	3	4	5
8	9	0	1	2	3	4	5	6
9	0	1	2	3	4	5	6	7

Template

99End Of Transfer Set0%

	1	2	3	4	5	6	7	8
1	2	3	4	5	6	7	8	9
2	3	4	5	6	7	8	9	0
3	4	5	6	7	8	9	0	1
4	5	6	7	8	9	0	1	2
5	6	7	8	9	0	1	2	3
6	7	8	9	0	1	2	3	4
7	8	9	0	1	2	3	4	5
8	9	0	1	2	3	4	5	6
9	0	1	2	3	4	5	6	7

Template



The purpose of this chapter and [chapter 9](#) is to:

- Provide a brief description of the presentation of Meridian 2 in the DXF transfer format.
- Data Exchange Format (DXF) (conforming to AutoCAD release 12 with extended entity data).  
As part of this description, data structure diagrams are used to give greater explanation where necessary.
- Provide Licensed Partners with as much detail as necessary to enable Meridian 2 files in DXF to be easily understood and processed by application software.

The term data structure used in these chapters refers to the organisation and sequence of the records in the data file and **not** to the geographical topology of the data.

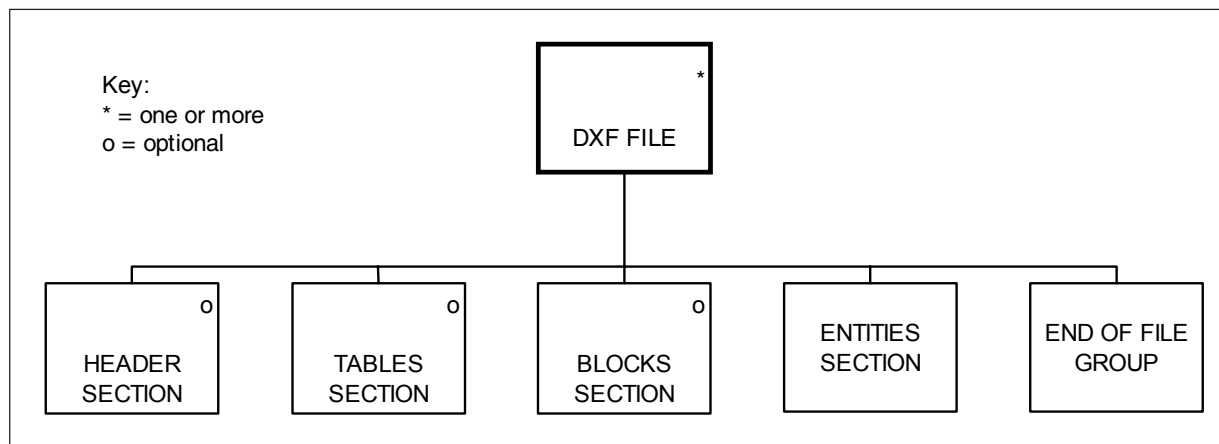
These chapters should be read in conjunction with [chapters 1, 2 and 3](#) which describe the content of Meridian 2.

This chapter describes the representation of Meridian 2 in Ordnance Survey's implementation of DXF. Meridian 2 is supplied to the product specification Meridian\_02.00

## An overview of Meridian 2 in DXF

### DXF

Meridian 2 is available in DXF, conforming to AutoCAD release 12, using extended entity data to store attributes. The transfer format is that defined by the NEDO Working Party for the exchange of two-dimensional drawings in the construction industry. An overview of the data structure of a Meridian 2 file in DXF is shown below.



## Structure of Meridian 2 in DXF

Meridian 2 has a limited link and node data structure; within this structure a feature may be a name, a point, or a line (or series of lines forming a coherent unit). Each feature is free standing; that is, its topological relationship to any other feature is **not** expressed in the data.

Features are classified by type and each type is placed in a separate DXF layer.

### Line features

A feature is a subjective entity; that is, so long as the constituent lines are of the same description (layer), a feature need not fully describe a logical piece of detail.

The extent of a feature is determined by digitising conventions and does not always coincide with the topology. Each linear feature is composed of a string of XY coordinate pairs implicitly joined by straight lines.

The colour and line weights of some layers may differ when DXF is used with certain software packages.

### Area features

Area features are not defined within vector link and node data. Features that might be thought of as area features are treated in the data as linear features, for example, a developed land use area boundary is treated as a polyline in layer G8056300.

### Name features

Name features are treated as free standing text data. There is no explicit relationship (in the data) between a text feature and the point or line feature to which it belongs.

Ordnance Survey distinguishes between layer name types – for example, place names and station names – by placing each name type in a separate DXF layer.

Text has position, expressed as a single coordinate pair held as X and Y offsets from the map origin (south-west corner). Text which is double or treble banked is treated as two or three separate features. The text string may be considered to be contained within an *envelope* whose bottom left hand corner is positioned on this coordinate pair. Text is oriented, that is, it may run from west to east across the map, or it may be plotted at some other angle measured anti-clockwise from grid east.

## Drawing content and format

### Coordinate system

The coordinate system is National Grid (NG).

The National Grid coordinates are to a resolution of 0.01 metre. This is the resolution of the source data.

### Height

No height attributes are applied to any feature.

[See page 3.21.](#)

### Layer names

See the AutoCAD publication *Layer Naming Convention for CAD in the Construction Industry*, version 2, which is based upon the guidelines laid down in BS 1192: Part 5 – *Guide for structuring of computer graphic information*.

Each layer name is an eight character string. The first four characters relate to the AUG/Autodesk system, with G (GIS) as the source of the information, and 800–899 as the part code. This product is **G805**.

The remaining four digits relate to existing Ordnance Survey digital map data in their own NTF system and are leading zero-filled.

For example:

G8055310 – Motorways

## Neatline

Neatlines around the extent of the map data are added as lines in the ENTITIES section (layer name G8050572).

## Grid

A grid is added as lines in the ENTITIES section (layer name G8050572). The grid is created by the translator and therefore must be specified before the translation takes place.

## Grid values

Full 100 000 metre National Grid easting and northing values followed by an m are added as text strings in the ENTITIES section (layer name G8050573) at each corner of the map extent either horizontal or vertical to read from the lower left corner of the tile.

Intermediate grid values are shown as multiples of 1000 metres from the nearest 100 km National Grid (layer name G8050572). These are horizontal.

## Meridian 2 DXF layers

Layer name	Feature name	Linetype	Line	Entity	Colour	Block
G8053000	Motorway	CONTINUOUS	3	POLYLINE	BLUE	
G8053001	A road	CONTINUOUS	1	POLYLINE	RED	
G8053002	B road	CONTINUOUS	1	POLYLINE	ORANGE	
G8053004	Minor road	CONTINUOUS	1	POLYLINE	WHITE	
G8053500	Road node	DOT		INSERT	GREEN	CIRCLE (small)
G8053501	Road edge node	DOT		INSERT	GREEN	CIRCLE (small)
G8056140	Railways	CONTINUOUS	3	POLYLINE	WHITE	
G8056142	Tunnelled railway	DASHED	1	POLYLINE	WHITE	
G8056155	Station	DOT		INSERT	RED	CIRCLE
G8056730	Railway node	DOT		INSERT	GREEN	CIRCLE (small)
G8056731	Railway edge node	DOT		INSERT	GREEN	CIRCLE (small)
G8056401	County boundary	DASHDOT	1	POLYLINE	GREEN	
G8056403	District boundary	DASHED	1	POLYLINE	GREEN	
	/London borough					
	/unitary authority					
G8056405	County/district	DASHDOT	1	POLYLINE	GREEN	
	/London borough					
	/unitary authority					
	boundary					
G8056800	Boundary neat line	CONTINUOUS	1	POLYLINE	GREEN	
G8056411	County seed	CONTINUOUS		INSERT	GREEN	SEEDPOINT
G8056415	District seed	CONTINUOUS		INSERT	GREEN	SEEDPOINT
G8056710	Boundary node	DOT		INSERT	GREEN	CIRCLE
G8056711	Boundary edge node	DOT		INSERT	GREEN	CIRCLE
G8056200	Coastline	CONTINUOUS	1	POLYLINE	BLUE	
G8056740	Coastline node	DOT		INSERT	GREEN	CIRCLE
G8056741	Coastline edge node	DOT		INSERT	GREEN	CIRCLE
G8056300	DLUA boundary	CONTINUOUS	2	POLYLINE	GREY	
G8056310	DLUA seed	CONTINUOUS		INSERT	GREY	DLUASEED
G8056720	DLUA node	DOT		INSERT	GREEN	CIRCLE
G8056721	DLUA edge node	DOT		INSERT	GREEN	CIRCLE
G8056801	DLUA neat line	CONTINUOUS	1	POLYLINE	GREY	



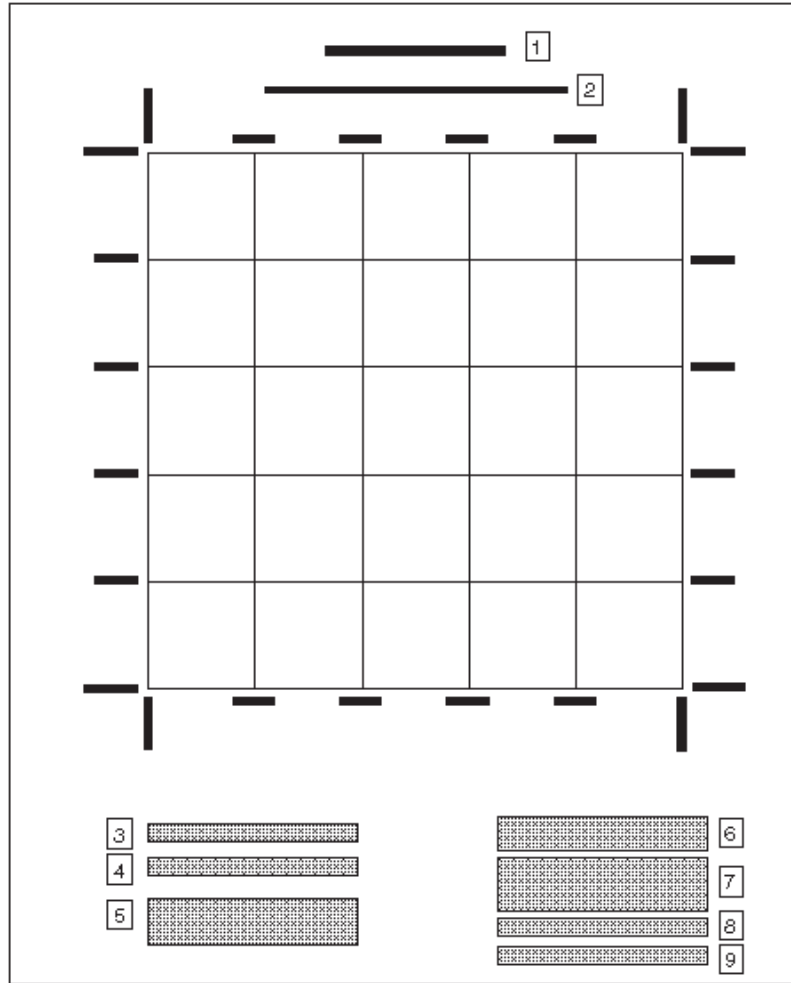
Layer name	Feature name	Linetype	Line	Entity	Colour	Block
G8056500	Place name	STANDARD		TEXT	WHITE	
G8056551	Station name	STANDARD		TEXT	WHITE	
G8050575	Default	CONTINUOUS	1	POLYLINE	WHITE	
G8050571	Footnotes	STANDARD		INSERT	WHITE	ME_FOOTNOTES
G8050572	Grid lines and values	CONTINUOUS	1	LINE/TEXT	WHITE	
G8050573	Grid values	STANDARD		TEXT	WHITE	
G8056223	River – small	CONTINUOUS	1	POLYLINE	CYAN	
G8056224	River – medium	CONTINUOUS	2	POLYLINE	CYAN	
G8056225	River – large	CONTINUOUS	3	POLYLINE	BLUE	
G8056230	Hidden water	CONTINUOUS	1	POLYLINE	BLUE	
G8056231	Aqueduct	CONTINUOUS	1	POLYLINE	BLUE	
G8056232	Dark link	CONTINUOUS	1	POLYLINE	RED	
G8056243	Canal	CONTINUOUS	1	POLYLINE	CYAN	
G8056255	Area water (lake)	CONTINUOUS	2	POLYLINE	BLUE	
G8056292	Area water (seed)	CONTINUOUS		INSERT	RED	SEEDPOINT
G8056552	Water text	STANDARD		TEXT	WHITE	
G8056770	Water feature (node)	DOT		INSERT	RED	CIRCLE
G8056771	Area water (node)	DOT		INSERT	RED	CIRCLE
G8056772	Area water (edge node)	DOT		INSERT	RED	CIRCLE
G8056773	Water feature (edge node)	DOT		INSERT	RED	CIRCLE
G8056803	Area water (neat line)	CONTINUOUS	2	POLYLINE	CYAN	
G8056664	Woodland boundary	CONTINUOUS	2	POLYLINE	MAGENTA	
G8056750	Woodland boundary node	DOT		INSERT	RED	CIRCLE
G8056663	Woodland seed	CONTINUOUS		INSERT	GREEN	SEEDPOINT
G8056751	Woodland (tile edge) node	DOT		INSERT	GREEN	CIRCLE
G8056802	Woodland (tile edge) polygon	CONTINUOUS	1	POLYLINE	MAGENTA	
G8056762	Gridded height	DOT		INSERT	YELLOW	

## DXF footnotes

The following footnotes are added as an insert BLOCK in the ENTITIES section of the DXF data file. The positions of the footnotes are indicated in [figure 8.1](#).

- Note 1:** Top margin centrally aligned, 1 750 ground metres, Layer: G8050571  
Ordnance Survey®
- Note 2:** Top margin centrally aligned, 1 500 ground metres, Layer: G8050571  
Meridian 2 data
- Note 3:** Lower left margin, 500 ground metres, Layer: G8050571  
Translation date dd Mmmmmmmmm CCYY
- Note 4:** Lower left margin, 500 ground metres, Layer: G8050571  
Tile reference number \_\_ \_\_ \_\_
- Note 5:** Lower left margin, 500 ground metres, Layer: G8050571  
Reproduced from Ordnance Survey Meridian™ 2 data with the permission  
of The Controller of Her Majesty's Stationery Office.  
© Crown Copyright CCYY
- Note 6:** Lower right margin, 500 ground metres, Layer: G8050571  
The derived scale of the product is dependent upon the source data.
- Note 7:** Lower right margin, 500 ground metres, Layer: G8050571  
The representation of a road, track or path is no evidence of a right  
of way. The alignment of tunnels is approximate.
- Note 8:** Lower right margin, 500 ground metres, Layer: G8050571  
Date of last amendment dd Mmmmmmmmm CCYY
- Note 9:** Lower right margin, 500 ground metres, Layer:G8050571  
Product specification.

Figure 8.1: Layout of footnotes





### General

The following paragraphs describe the DXF group and section structure for the transfer of Meridian 2.

It is assumed that the reader of this chapter is familiar with the AutoCAD, release 12, reference manual, which is published by Autodesk Ltd, Cross Lane, GUILDFORD, GU1 1UJ (web site: [www.autodesk.co.uk](http://www.autodesk.co.uk)), or an equivalent document published by the reader's software supplier if a CAD package other than AutoCAD is to be used.

Meridian 2 DXF files containing Ordnance Survey data can be very large and so are supplied on CD-ROM media only.

This chapter gives a detailed breakdown of the data structure of Meridian 2 in DXF.

This is a two-stage procedure, which consists of:

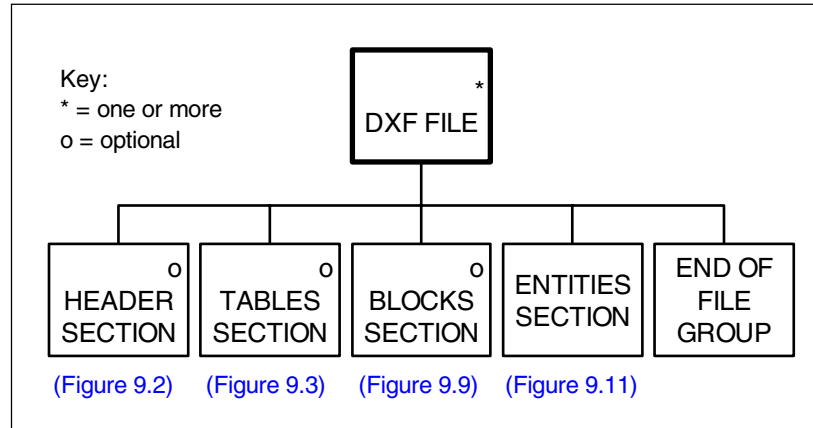
1. Diagrammatic view of the data structure with a preceding outline description of that part of the data structure.
2. Detailed examples of the record sequence and contents of the data structure. A diagram of the record group precedes each example.

## Data structure

The following diagrams (figures 9.1–9.14) represent the data structure of DXF. Where one element of a figure is the starting point for another figure, this is indicated beneath the relevant box.

For details of the specification for the DXF group, see the AutoCAD, Release 12, reference manual.

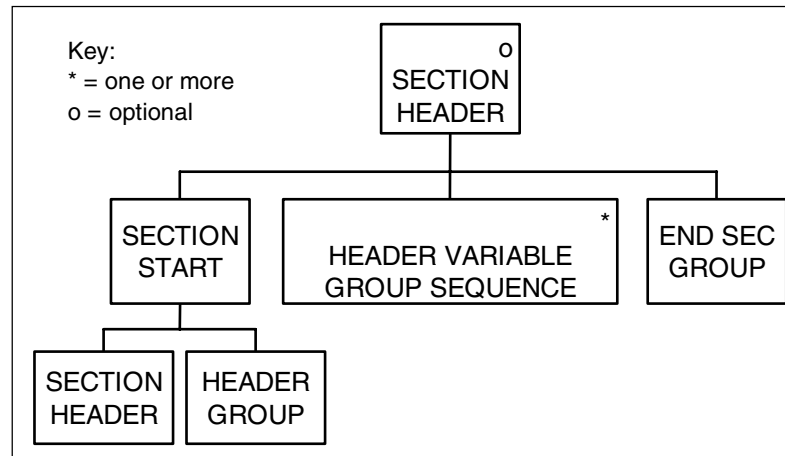
**Figure 9.1:** Level 1



## Header

The header will be constructed as follows, with only those fields being supplied.

**Figure 9.2:** Level 2



The header must be structured in the following order.

0

SECTION

2

HEADER

9

\$ACADVER

AutoCAD drawing database version number

1

AC1009

This indicates Release 11 or 12 (not 9)

9

\$EXTMIN	X and Y drawing extents lower left corner
10	
nnnnnnnn . nn	Minimum eastings, (National Grid coordinates)
20	
nnnnnnnn . nn	Minimum northings, (National Grid coordinates)
9	
\$EXTMAX	X and Y drawing extents, upper right corner
10	
nnnnnnnn . nn	Maximum eastings, (National Grid coordinates)
20	
nnnnnnnn . nn	Maximum northings, (National Grid coordinates)
9	
\$LIMMIN	X and Y drawing limits, lower left corner
10	
nnnnnn . n	X drawing limit, lower left corner, (in the AutoCAD World Coordinate System (WCS))
20	
nnnnnn . n	Y drawing limit, lower left corner, (in WCS)
9	
\$LIMMAX	X and Y drawing limits, upper right corner
10	
nnnnnn . n	X drawing limit, upper right corner, (in WCS)
20	
nnnnnn . n	Y drawing limit, upper right corner, (in WCS)
9	
\$LTSCALE	Global linetype scale
40	
100.0	
9	
\$ATTMODE	Attribute visibility
70	
1	This sets attributes to <i>on</i> when the file is open

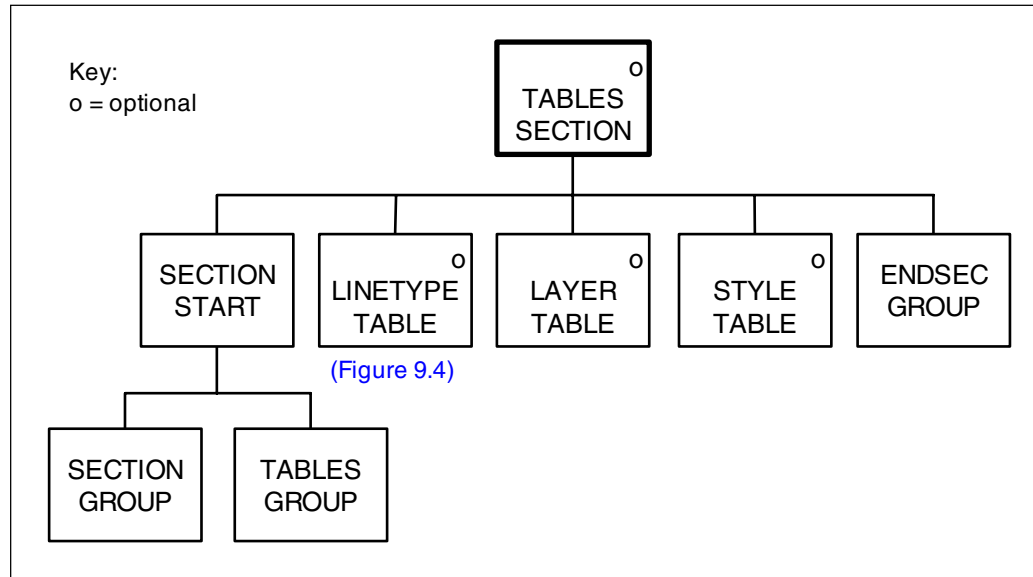


9		
\$FILLMODE		Fillmode <i>on</i> if non-zero
70		
1		
9		
\$TEXTSIZE		Default text height
40		
1.0		
9		
\$TEXTSTYLE		Current text style name
7		
STANDARD		
9		
\$CELTYPE		Entity linetype name
6		
BYLAYER		
9		
\$CECOLOR		Entity colour name
62		
256		Indicates colour ID BY LAYER
9		
\$LUNITS		Units format for coordinates and distances
70		
2		
9		
\$LUPREC		Units precision for coordinates and distances
70		
1		
9		
\$AUPREC		Units precision for angles
70		

```
          1
9
$ANGBASE      Angle zero direction
50
0.0
9
$ANGDIR      Angle rotation
70
          0      1 = clockwise angles, 0 = anti-clockwise angles
9
$PDMODE      Point display mode
70
          1
9
$PDSIZE      Point display size
40
0.0
9
$PLINEGEN    Sets the linetype pattern generation around the vertices of a 2-dimensional Polyline
70
          1
          0
ENDSEC      End of Section
```

## Tables

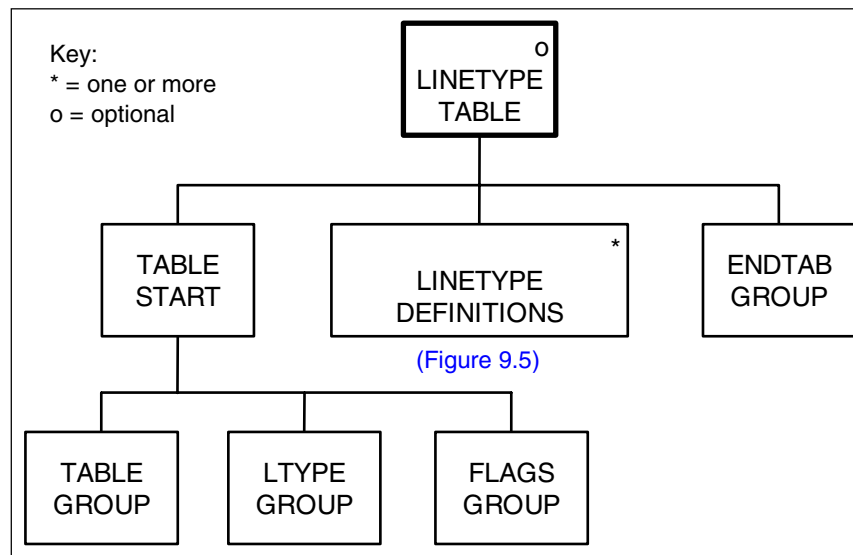
Figure 9.3: Level 2



The Tables Section will follow the Header Section and will contain three tables:

- Linetype Table.
- Layer Table.
- Style Table.

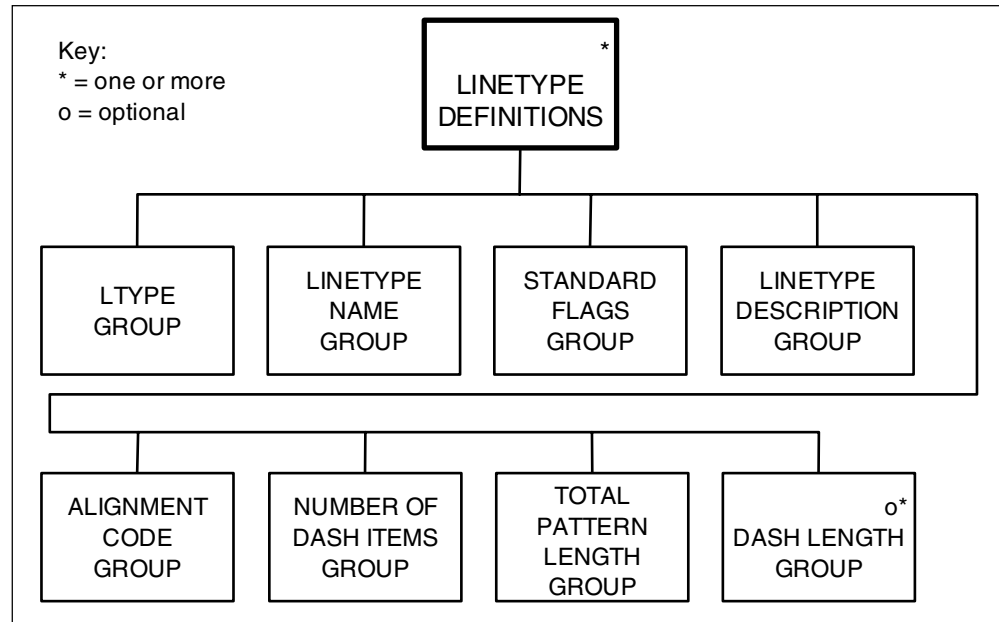
**Figure 9.4:** Linetype Table Level 3



The Linetype Table will contain definitions for the following line types:

- solid line (CONTINUOUS)
- dashed line (DASHED)
- dashdot line (DASHDOT)
- dotted line (DOT)

Figure 9.5: Level 4



Thus:

0  
 TABLE  
 2  
 LTYPE  
 70  
 5  
 0  
 LTYPE

2  
CONTINUOUS

70

64

3  
Solid Line

72

65

73

0

40

0.0

0

LTYPE

2

DASHED

70

64

3

-----

72

65

73

2

40

0.75

49

0.5

49

-0.25

0

LTYPE  
2  
DASHDOT  
70  
0  
3

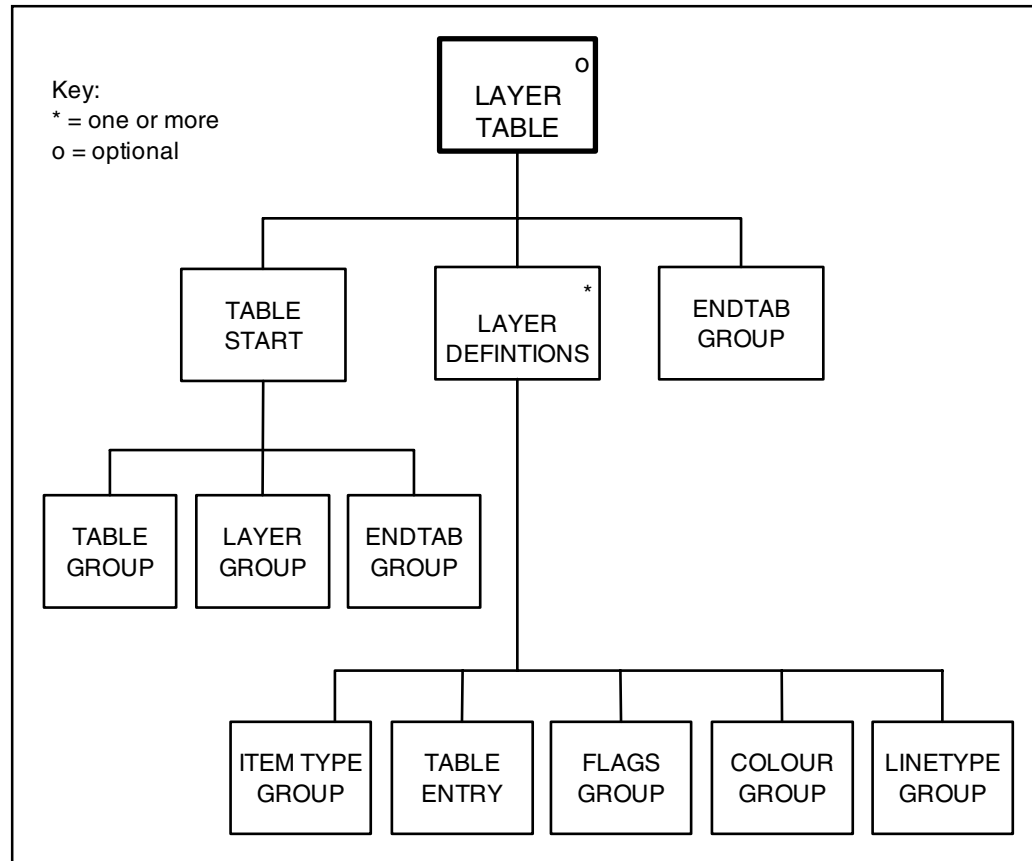


LTYPE  
2  
DOT  
70  
64  
3  
72  
65

73  
2  
40  
0.25  
49  
0.0  
49  
-0.25  
  
0  
ENDTAB

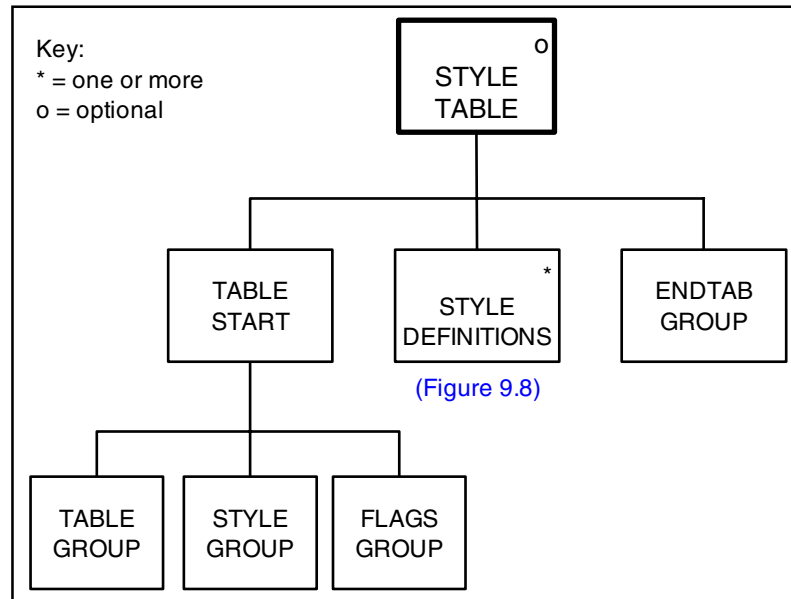


Figure 9.6: Level 3



Details of the Layer Table can be seen on [page 8.6](#).

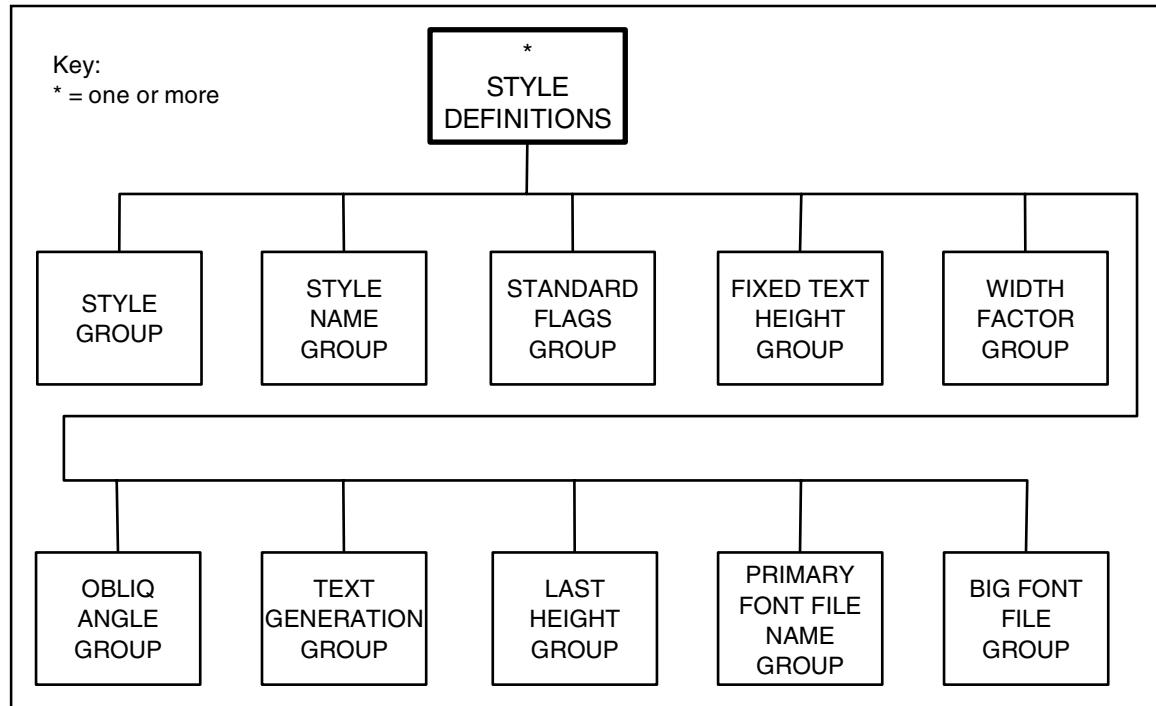
**Figure 9.7:** Style Table level 3



The Style Table will contain the text file load instructions for:

- SIMPLEX.SHX
- MONOTEXT.SHX

Figure 9.8: Level 4



## Blocks

**Figure 9.9:** Level 2

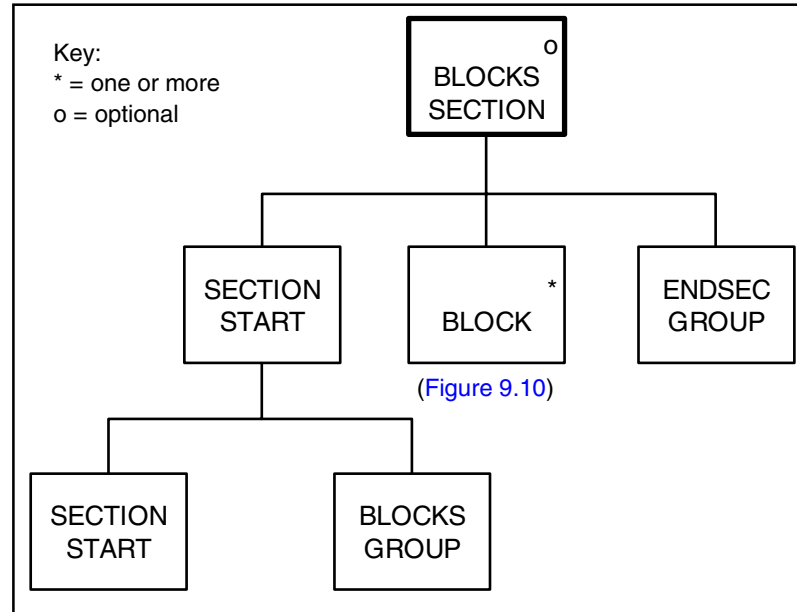
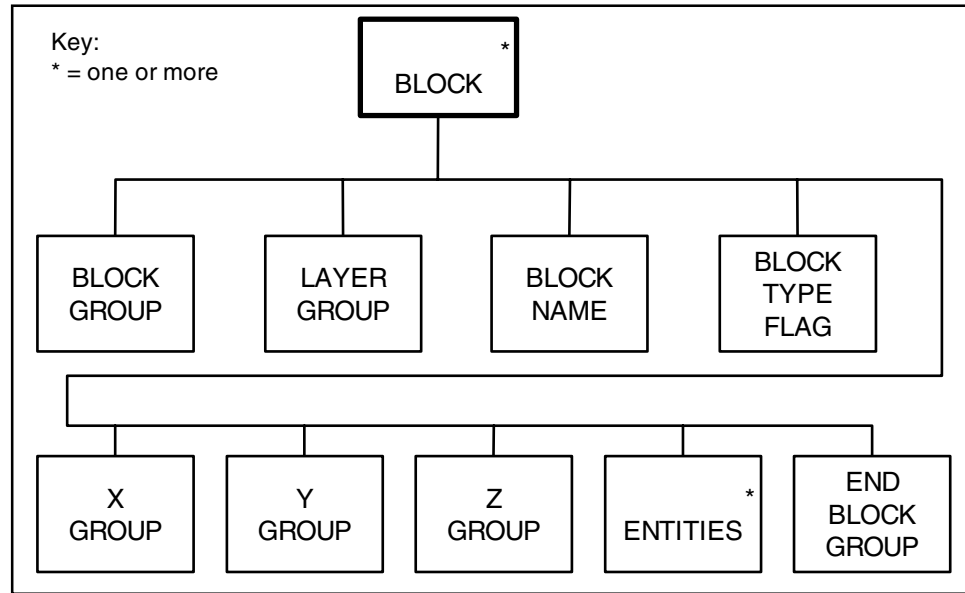


Figure 9.10: Level 3



## Entities Section

The Entities Section will contain DXF entities for:

- Ordnance Survey map footnotes data (INSERT entities);
- Grid and neatline (TEXT and LINE entities); and
- Ordnance Survey features (TEXT, POLYLINE and INSERT entities)

Extended entity data will be used to store attributes.

The structure of each different entity is as follows:

a. INSERT entities – these consist of:

- INSERT entity type group (Attribute number 0).
- Layer name group (8).
- Block name group (2).
- X coordinate group (10).
- Y coordinate group (20).
- X scale factor (41) [optional].
- Y scale factor (42) [optional].
- Orientation group (50) [optional if 0].

b. LINE entities – these consist of:

- LINE entity type group (0).
- Layer name group (8).
- Start X coordinate group (10).
- Start Y coordinate group (20).
- End X coordinate group (11).
- End Y coordinate group (21).

- c. POLYLINE entities – these consist of:
- POLYLINE entity type group (0).
  - Layer name group (8).
  - Vertices follow flag group (66).
  - Polyline flags group (70) [optional].
  - A number of VERTEX entities [shown on the next page].
  - SEQEND group (0).
- d. VERTEX entities – these consist of:
- VERTEX entity type group (0).
  - Layer name group (8).
  - X coordinate group (10).
  - Y coordinate group (20).
  - Z coordinate group (30).
- e. TEXT entities – these consist of:
- TEXT entity type group (0).
  - Layer name group (8).
  - X coordinate group (10).
  - Y coordinate group (20).
  - Text height group (40).
  - Text string group (1).
  - Justify type group (72) [optional if 0].
  - Justify type group (73) [optional if 0].
  - Orientation group (50) [optional if 0].
  - Text style group (7) [optional].
  - Align X group (11) [only present if Justify type group is present and has a value of 2].
  - Align Y group (21) [only present if Justify type group is present and has a value of 2].

- f. EXTENDED entities – these consist of:
- Application name (1001).
  - Control string (1002).
  - String (1000) [one or more].
  - Control string (1002).

**Figure 9.11:** Level 2

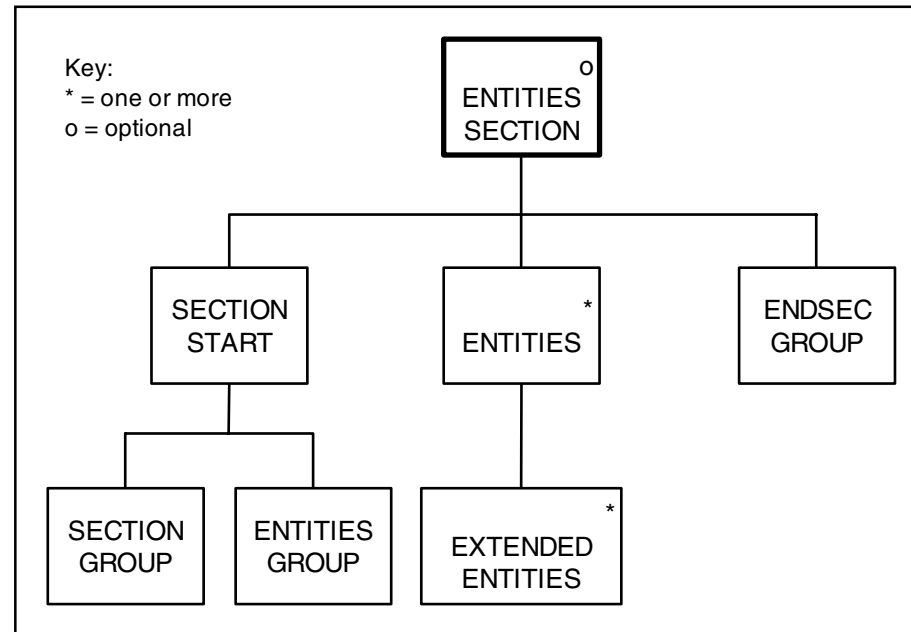
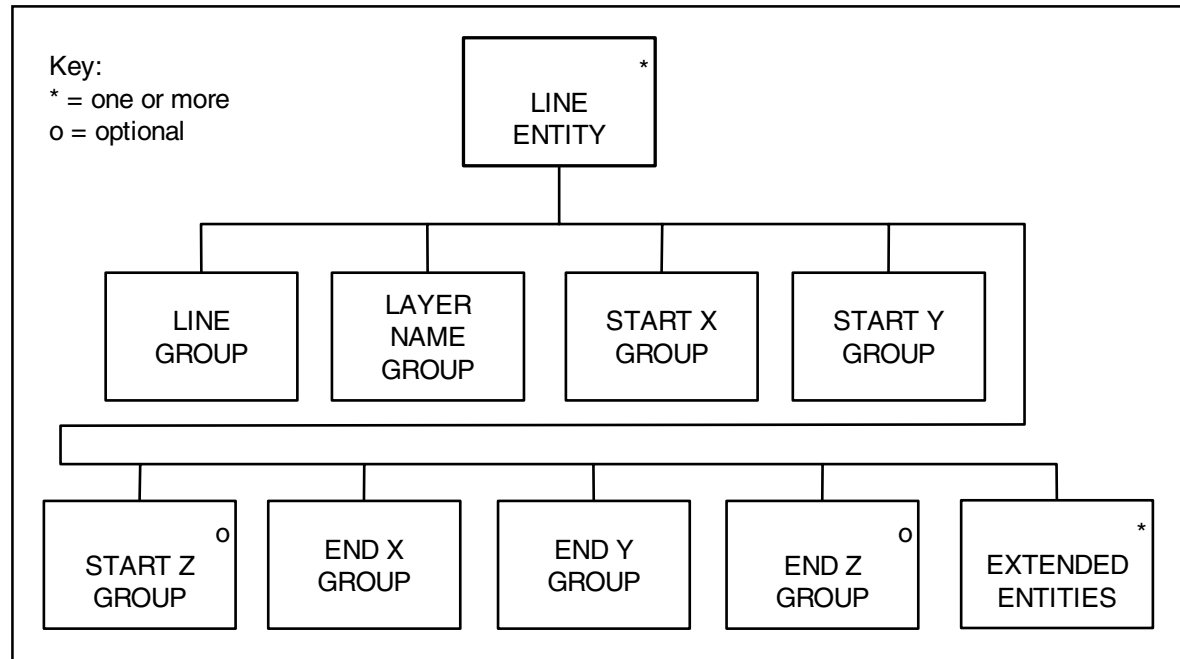




Figure 9.12: Level 3



**Figure 9.13:** Level 3

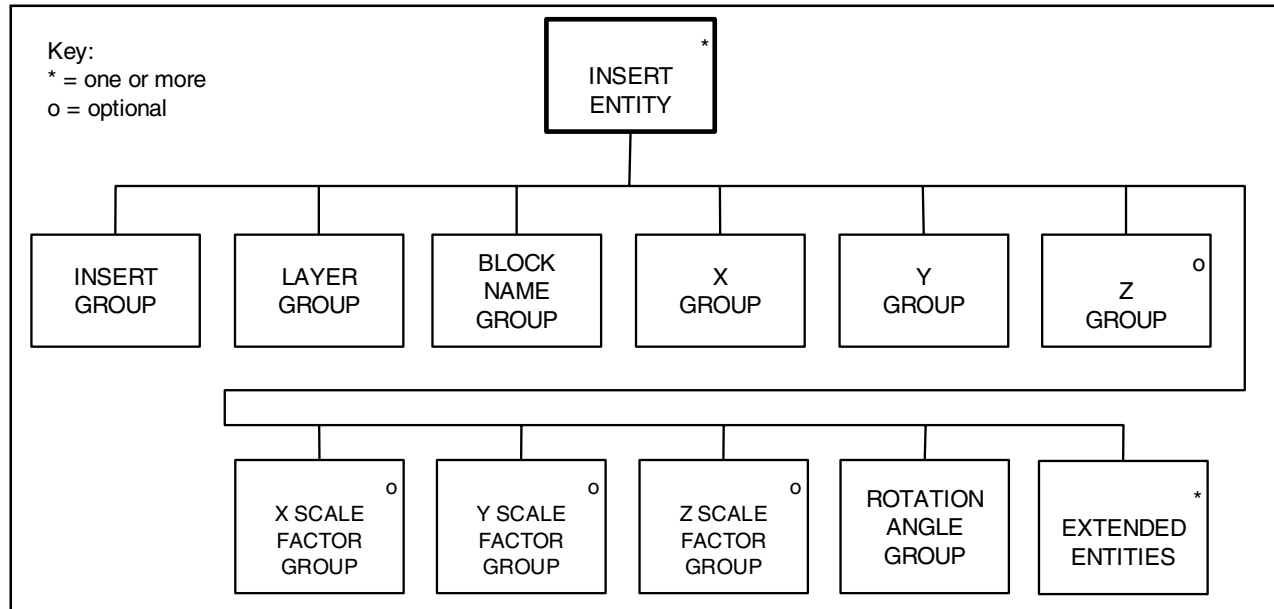
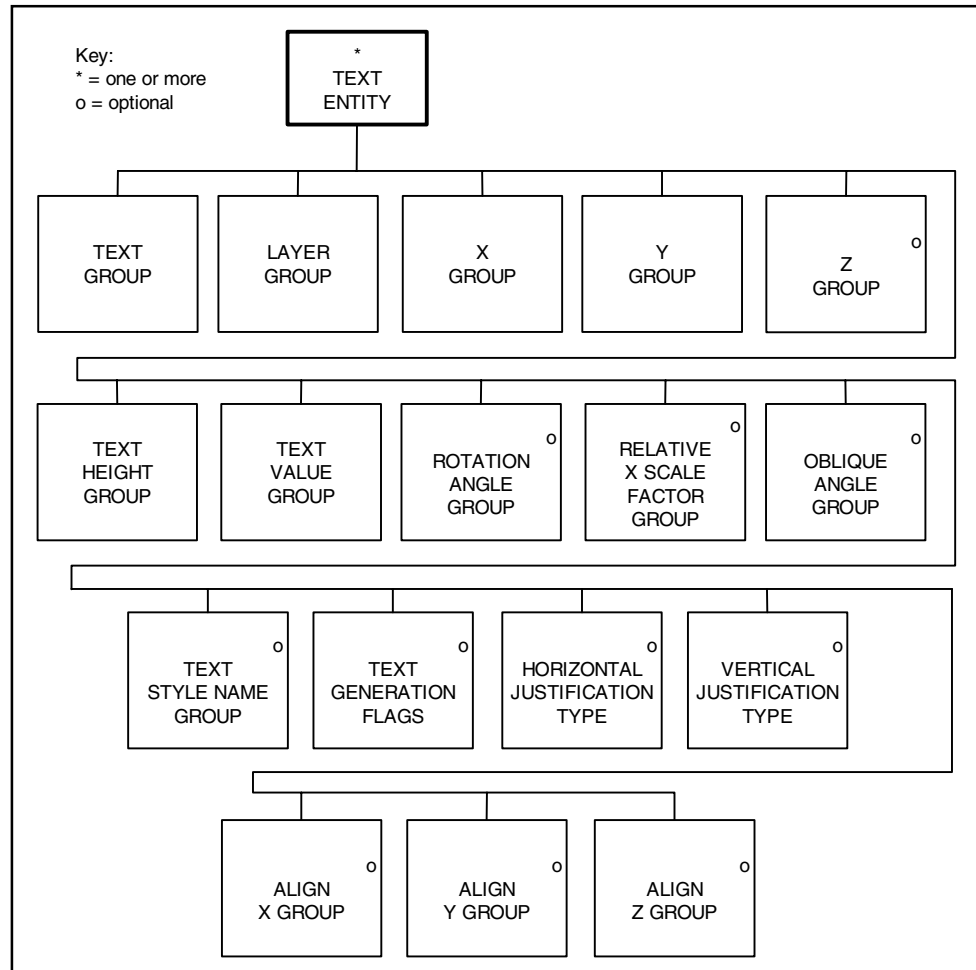
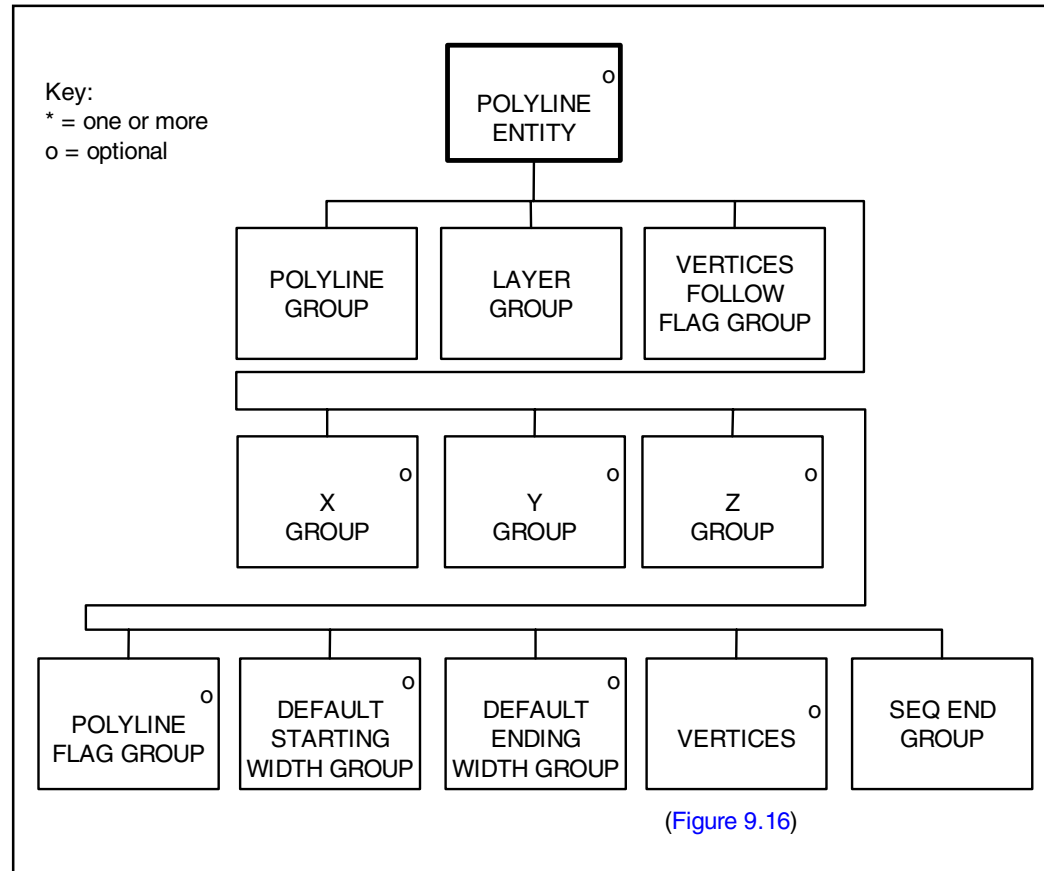


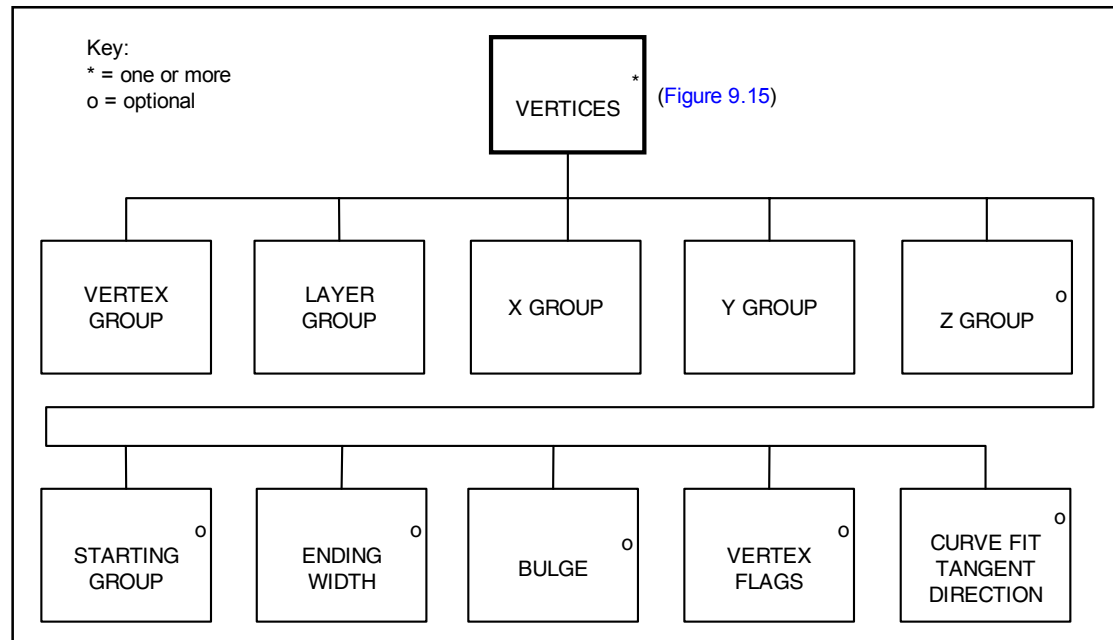
Figure 9.14: Level 3



**Figure 9.15:** Level 3



**Figure 9.16:** Vertex entity (level 4)



## End of File Group

This group will end with DXF EOF (End Of File) group.



## Appendix A Glossary

### **accuracy**

The closeness of the results of observations, computations or estimates to the true values or the values accepted as being true. Accuracy relates to the exactness of the result, and is the exactness of the operation by which the result is obtained.

### **administrative area**

A blanket term used by Ordnance Survey to refer to all public administrative areas, specifically local government management and electoral areas.

### **American Standard Code for Information Interchange (ASCII)**

A seven-bit code for encoding a standard character set.

### **area**

A spatial extent defined by circumscribing lines that form a closed perimeter that does not intersect itself.

### **area seed**

A point within an area that can be used to carry the attributes of the whole area, for example, ownership, address and use type.

### **attribute**

An attribute is a property of an entity, usually used to refer to a non-spatial qualification of a spatially referenced entity. For example, a descriptive code indicating what an entity represents or how it should be portrayed.

### **attribute class**

A specific group of attributes, for example, those describing measure, serviceability, structure or composition.

### **attribute code**

An alphanumeric identifier for an attribute type.

### **attribute value**

A specific quality or quantity assigned to an attribute.

**basic scale**

The scale at which the survey is maintained. For Ordnance Survey mapping, three scales (1:1250, 1:2500 and 1:10 000) are used. Any area is only maintained at one basic scale.

**block**

Data on magnetic media may be recorded in blocks of characters for more efficient movement within or between computer systems. The length of the block will vary according to the medium and the data transfer format used.

**boundary**

A boundary is the limit of a pre-defined and established area whose limit is determined by one or more [lines](#), for example, county area boundary and developed land use area boundary.

**byte**

A unit of computer storage of binary data usually comprising 8 bits, equivalent to a character. Hence [megabyte](#) (Mb) and gigabyte (Gb).

**CAD**

Computer-aided design

**cartography**

The organisation and communication of geographically related information in either graphic or digital form. It can include all stages from data acquisition to presentation and use.

**character**

A distinctive mark; an inscribed letter; one of a set of writing symbols.

**character string**

A one-dimensional array of characters held either in memory or in another storage medium.

**coding**

Allocation of a feature code to a feature being created from constituent construction data – points and/or segments; with optional linking to an existing feature of the same feature code.

**compact disc - read only memory (CD-ROM)**

A data storage medium. A 12-cm disc similar to an audio CD. Ordnance Survey uses the writable-CD, a WORM (write once read many) device. The digital bits are encoded into a vegetable dye and, once written, cannot be erased by overwriting with subsequent data. Laser reads the disc.



**continuation mark**

A logical record may contain more data than can be held in a single physical record. The physical record contains a continuation mark – the penultimate character of the record in NTF – to indicate whether more data is to be found in a continuation record.

**continuation record**

A specific NTF term. A continuation record is used where space does not allow one logical record to be contained wholly within one physical record.

**coordinate pair**

A coordinate pair is an easting and a northing.

**coordinates**

Pairs of numbers expressing horizontal distances along original axis. Alternatively triplets of numbers measuring horizontal and vertical distances. Row and column numbers of pixels from raw imagery are not considered coordinates for the purpose of the standard.

**copyright**

Copyright is a legal property right which enables the creator of an original work to protect it from unauthorised use. Through the *Copyright, Designs and Patents Act 1988*, Crown copyright continues to subsist in all Ordnance Survey products until the end of the period of 50 years from the end of the year in which they were published, and in the case of data from the end of the year in which it was extracted from the Ordnance Survey database. Crown copyright is vested in The Controller of Her Majesty's Stationery Office, who has delegated powers to the Director General, Ordnance Survey for the administration of copyright in publications and data, including the determination of terms and conditions under which permission for their reproduction is given.

**currency**

An expression of the up-to-dateness of data.

**data**

A representation of facts, concepts or instructions in a formalised manner suitable for communication, interpretation or processing.

**data capture**

The encoding of data. In the context of digital mapping, this includes map digitising, direct recording by electronic survey instruments and the encoding of text and attributes by whatever means.

**data format**

A specification that defines the order in which data is stored or a description of the way data is held in a file or record.

**data model**

An abstraction of the real world which incorporates only those properties thought to be relevant to the application or applications at hand. The data model would normally define specific groups of [entities](#) and their [attributes](#) and the relationship between these entities. A data model is independent of a computer system and its associated data structures. A map is one example of an analogue data model.

**database**

An organised, integrated collection of data stored so as to be capable of use in relevant applications, with the data being accessed by different logical paths. Theoretically it is application-independent, but in reality it is rarely so.

**dataset**

An Ordnance Survey term for a named collection of logically related features arranged in a prescribed manner. For example, all water features. A dataset has more internal structure than a layer and is related to another dataset only by position.

**DDS**

Digital Data Storage

**density**

A measure of the number of units of data held on a stated length of storage surface.

**detached part**

A term applying to a part of a local government or parliamentary area which is completely surrounded by other local government or parliamentary areas, and is not connected to the *parent* area by direct access on the ground.

**digital**

Data which is expressed as numbers (digits) in computer readable form is said to be digital.

**digital map**

Any map sold by Ordnance Survey or its agents in any form, that is, on computer-readable media or as hard copy on paper and/or film or microfilm – produced mainly, or wholly, using computerised means.

**digital map data**

The digital data required to represent a map. The data includes not only map detail but also feature header data, map header data and management data.

**digitising**

The process of converting analogue maps and other sources to a computer readable form. This may be point digitising, where points are only recorded when a button is pressed on a cursor, or stream digitising where points are recorded automatically at preset intervals of either distance or time as the cursor is traced along a map feature.

**distinctive name**

A text feature consisting of text string(s) which form(s) a proper name.

**DXF (Data Exchange Format)**

A proprietary data format, devised by Autodesk, by which digital drawings may be transferred between users of CAD (computer-aided design) systems. DXF has become an industry standard data format and is used for the transfer of some Ordnance Survey data products.

**eastings**

See [rectangular coordinates](#).

**edge match**

The process of ensuring that data along the adjacent edges of map sheets, or some other unit of storage, matches in both positional and attributes terms.

**entity**

Something about which data is stored in a databank or database. For example, building or tree. The data may consist of relationships, attributes, positional and shape information and so on. Often synonymous with feature.

**Extended Binary Coded Decimal Interchange Code (EBDCDIC)**

An eight-bit character encoding scheme.

**Extent of the realm (EOR)**

The external bounding lines of Land-Line® data is EOR. *The Territorial Waters Jurisdiction Act 1878* and the *Territorial Waters Order in Council 1964* confirm that EOR of Great Britain as used by Ordnance Survey is properly shown to the limit of mean low water (mean low water springs in Scotland) for the time being (except where extended by Parliament).

**feature**

An item of detail within a map which can be either a point or symbol, a line or text.

**feature classification record**

A specific named NTF record, which lists the feature codes in use in the current database.

**feature code (FC)**

An alphanumeric attribute code used in digital map data to describe each feature in terms of the object surveyed, its representation on the map, or both.

**feature serial number (FSN)**

A number used as a feature identifier usually allocated on a sequential basis. For example, the order in which features are digitised.

**field**

A specific part of a record containing a unit of data, such as the date of digitising. The unit of data may be a data element or a data item. In NTF, a field is a subdivision of a physical record. Every field has a name and a pre-defined interpretation.

**file**

An organised collection of related records. The records on a file may be related by a specific purpose, format or data source – the records may or may not be arranged in sequence. A file may consist of records, fields, words, bytes, characters, or bits.

**font**

The style of text character used by a printer or plotter.

**format**

The specified arrangement of data. For example, the layout of a printed document, the arrangement of the parts of a computer instruction, the arrangement of data in a [record](#).

**geographical information system (GIS)**

A system for capturing, storing, checking, integrating, analysing and displaying data that is spatially referenced to the Earth. This is normally considered to involve a spatially referenced computer [database](#) and appropriate applications software.

**geometric structure**

The ground is modelled in the data as a series of lines and points.

**gigabyte (Gb)**

1 073 741 824 bytes; a measure of data storage capacity.

**grid**

The planimetric frame of reference. For example, the National Grid.

**hard copy**

A print or plot of output data on paper or some other tangible medium.

**junction**

A connection between two or more links at a common node.

**kilobyte (Kb)**

1024 bytes; a measure of data storage capacity.

**layer**

A subset of digital map data, selected on a basis other than position. For example, one layer might consist of all features relating to roads and another to railways.

**line**

A series of connected coordinated points forming a simple feature with homogeneous attribution.

**line feature**

The spatial abstraction of an object in one dimension. Lines may intersect with other lines. They are defined as a series of two or more coordinates and may be curved or straight. Curved lines consist of a series of very short straight line segments. Lines may be concurrent with other lines under certain conditions. As an object abstraction a line has no width.

**line segment**

A vector connecting two coordinated points.

**linear feature**

Map feature in the form of a line, for example, road centrelines, that may or may not represent a real-world feature.

**link**

Links are the representation of line features. They are made up of one or more consecutive, non-intersecting, link segments with common attributes, between two terminating nodes. Links have no connection with other links except at the start or end via common (shared) terminating nodes (points). All links contain their terminating coordinates. Links may form the boundaries of polygons and may be shared between polygons. See also [line](#).

**link and node data**

A form of vector data in which linear features are represented as links. Links are terminated where they intersect other links. These intersection points, and link ends, may carry nodes whose feature records express the geometric relationships between links.

**link and node structure**

A data structure in which links and nodes are stored with cross referencing.

**map**

The representation on a flat surface of all or part of the earth's surface, intended to be communicated for a purpose or purposes, transforming relevant geographic data into an end-product which is visual, digital or tactile.

**map generalisation**

A reduction in map detail, so that the information remains clear and uncluttered when map scale is reduced. May also involve resampling to larger spacing and/or a reduction in the number of points in a line.

**map header**

Data at the start of the digital map file describing that data. It may contain information on the source and history of the geometric data within the map and the coordinate system in use as well as holding information essential to the management of Ordnance Survey's digital mapping system.

**map scale**

The ratio between the extent of a feature on the map and its extent on the ground normally expressed as a representative fraction, for example, 1:1250 or 1:50 000.

**megabyte (Mb)**

1 048 576 bytes; a measure of data storage capacity.

**name or text feature**

The proper name or label of an object (real-world) or feature (object abstraction) consisting of one or more text strings. A name position is defined by a coordinate pair.

**National Grid**

A unique referencing system which can be applied to all Ordnance Survey maps of Great Britain (GB) at all scales. It is based on 100 km squares covering the whole of GB based on a Transverse Mercator Projection. It is used by Ordnance Survey on all post-war mapping to provide an unambiguous spatial reference in GB for any place or entity whatever the map scale.

**National Transfer Format (NTF)**

A format designed in 1988 specifically for the transfer of spatial information; it is published as *British Standard BS 7567* and is administered by the British Standards Institution. It is now the standard transfer format for Ordnance Survey digital map data.

**node**

An object representation of a point which either does not form any part of a link (isolated node or polygon seed point); or is the representation of a point at the start or end of a link (terminating node). The position of a node is defined by a single coordinate pair – which is repeated within all links logically connected at that node and/or containing it. A node is only deleted if the link containing it as a terminating node is deleted.

**northings**

See [rectangular coordinates](#).

**orientation**

Orientation of a point or a text feature is measured in degrees anticlockwise from grid east.

**origin**

The zero point in a system of [rectangular coordinates](#).

**packing**

Spaces used as fillers to complete a record or field.

**pecked line**

A line drawn as a series of dashes.

**physical record**

A physical record may be fixed length containing 80 characters or variable length containing **up to** 80 characters.

**point**

A zero-dimensional spatial abstraction of an object represented as a coordinate pair.

**point and line data**

A form of vector data designed for map production in which all map features are designated as points, lines or text. Point and line data does not carry the topological relationships between features.

**point feature**

A zero-dimensional spatial abstraction of an object with its position defined by a coordinate tuple. Points are represented by nodes which may be isolated or part of a link (terminating). Points may also be represented by symbols, which may have attributes such as rotation and size.

**polygon**

Polygons are a representation of areas. A polygon is defined as a closed line or perimeter completely enclosing a contiguous space and made up of one or more links. At least one node occurs on the perimeter of a polygon where the bounding link completes the enclosure of the area. There may be many nodes connecting the bounding links of a polygon. Links may be shared between polygons. Polygons may wholly contain other polygons, or be contained within other polygons. Each may contain a single isolated node (seed point) which identifies the polygon.

**polygon boundary**

The link or links which enclose a polygon, projected into the horizontal plane.

**polygon point**

See [seed point](#).

**positional accuracy**

The degree, to which the coordinates define a point's true position in the world, directly related to the spheroid/projection on which the coordinate system is based.

**precision**

The exactness with which a value is expressed, whether the value be right or wrong.

**record**

A set of related data fields grouped for processing.



**recording format**

The logical and/or physical levels of the protocol governing the laying down of data on the physical transfer medium.

**rectangular coordinates**

Also known as X-Y coordinates and as [eastings](#) and [northings](#). These are two-dimensional coordinates which measure the position of any point relative to an arbitrary origin on a plane surface, for example, a map projection, a digitising table or a VDU screen.

**resolution**

A measure of the ability to detect quantities. High resolution implies a high degree of discrimination but has no implication as to [accuracy](#). For example, in a collection of data in which the [coordinates](#) are rounded to the nearest metre, resolution will be 1 m but the accuracy may be  $\pm 5$  m or worse.

**section**

In NTF terminology, a subdivision of a database. In Ordnance Survey terms this equates to a single map sheet, that is, a digital map file or a tile.

**seed**

A seed is a digitised point within an area, usually a defined polygon, for example, a lake or woodland, but not always, for example, a geographical seed such as the South Downs.

**seed point**

A coordinated point (an isolated node) within an area (usually a defined polygon) to which alphanumeric information may be attached as an attribute, for example, a name or a feature code. Also known as a polygon seed, area seed, or representative point.

**segment**

A chord defined by two consecutive [coordinates](#) in a line string.

**source scale**

The scale of the source information from which the map was digitised, that is, the scale of survey for a basic scale map, or the scale of the source map for a derived map.

**spatial data**

Data which includes a reference to a two- or three-dimensional position in space as one of its attributes. It is used as a synonym for geometric data.

**structured data**

Data within which collections of features (of any type) form objects. Topographically structured data also contains topological information defining the relationships between features and objects.

**terminator**

A character, character string, field, or record used to signal the end of a record, section, volume or database.

**text coordinates**

Each text feature has a *start-of-text* coordinate which is digitised.

**text feature**

A free standing text string in the digital data describing a feature, or particular instance of a feature, for example, Factory or Acacia Avenue.

**text height**

The height at which a text string is intended to be plotted out at the nominal map scale. This information is included in the feature header of the text feature.

**text position**

See text coordinates. Also known as *original digitising position*.

**tile**

Broadly synonymous with digital map file, it implies evenly sized map sheet units.

**topographic database**

A database holding data relating to physical features and boundaries on the Earth's surface.

**topography**

Topography is the study of the physical features of the Earth. A topographic map's principal purpose is to portray and identify the features of the Earth.

**topology**

The study of the properties of a geometric figure which are not dependent on position, such as connectivity and relationships between lines, nodes and polygons.

**transfer format**

The format used to transfer data between computer systems. In general usage this can refer not only to the organisation of data, but also to the associated information, such as attribute codes, which are required in order to successfully complete the transfer.

**transfer medium**

The physical medium on which digital data is transferred from one computer system to another. For example, CD-ROM.

**transfer set**

A specific NTF term for the data, together with its supporting information, which the customer receives.

**update**

The process of adding to and revising existing digital map data to take account of change.

**vector**

A straight line joining two data points.

**vector data**

Positional data in the form of coordinates of the ends of line segments, points, text positions and so on.

**volume**

A physical unit of the transfer medium, that is, a single disc.





